

GERDA®

PRODUCENT DRZWI KLASY PREMIUM



DRZWI DO DOMÓW

THERMO PRIME | THERMO PREMIUM | OPTIMA

TEDEE POWERED BY GERDA	3
DRZWI DOSTĘPNE OD RĘKI	4
CO WARTO WIEDZIEĆ O DRZWIACH GERDA	8
O CZYM PAMIĘTAĆ WYBIERAJĄC DRZWI GERDA	9
GERDA THERMO PRIME 75	12-13
GERDA THERMO PREMIUM 75	14-15
GERDA THERMO PREMIUM 60	16-17
GERDA OPTIMA 60	20-21
GERDA OPTIMA 50	22-23
DRZWI AIR GLASS	26-31
DRZWI QUADRO	32-53
DRZWI ELITE 3D	54-55
DRZWI TEMPO	56-75
DRZWI CLASSIC	76-85
DRZWI OPTIMA 60 DUO	86-87
DOŚWIETLA ALUMINIOWE	88-89
FEERIA BARW	90-91
ZESTAW OSPRZĘTU	92-93
WYPOSAŻENIE OPCJONALNE	94-99
WYMIARY DRZWI I OŚCIEŻNIC	100-105

ZMIŃ SWÓJ SMARTFON W INTELIGENTNY ZAMEK DO DRZWI



OTWIERAJ DRZWI SMARTFONEM

Otwieraj i zamykaj drzwi oraz sprawdzaj status zamka z dowolnego miejsca na świecie. Dzięki funkcji automatycznego otwierania nie musisz wyjmować smartfona z kieszeni czy torebki. Zamek sam wykryje Twoją obecność i wpuści Cię do domu. W analogiczny sposób możesz korzystać z funkcji samozamykania.

WYDAJNY AKUMULATOR

Inżynierowie Gerdy przy współpracy z Instytutem Badawczym z Korei Południowej opracowali dedykowany i bardzo wydajny akumulator o niewielkich rozmiarach. Bateria zapewnia mechanizmowi prąd na pół roku pracy. Gdy jednak zajdzie potrzeba ładowania, zamek sam Cię o tym poinformuje, baterię naładujesz w jedną noc.

GWARANCJA BEZPIECZEŃSTWA

Mechanizm napędzający zamek, to innowacyjna i opatentowana konstrukcja opracowana przez inżynierów Gerdy. Oprogramowanie stworzyli eksperci IoT z firmy tedee. Dzięki intuicyjnej aplikacji możesz monitorować kto i kiedy zamykał lub otwierał drzwi oraz przyznawać zdalnie wirtualne klucze.

ZESTAW

TEDEE LOCK + TEDEE BRIDGE + WKŁADKI W KLASIE 6

CENA

1650 zł (dopłata do ceny drzwi)



WKŁADKA W KLASIE 6, W ZESTAWIE

- ✓ ANTYWŁAMANIOWA WKŁADKA BĘBENKOWA. NOWA KONSTRUKCJA WKŁADKI Z ZABEZPIECZENIEM PRZED OTWARCIEM METODĄ „BUMPINGU”, SKUTECZNYMI ROZWIĄZANAMI CHRONIĄCYMI PRZED ROZWIERCENIEM.



ZAMONTUJ ZAMEK TEDEE

- ✓ WSUŃ ZAMEK NA WKŁADKĘ GERDA, DOPASUJ POZYCJĘ ZAMKA I ZAMOCUJ JEDNYM WKRĘTEM. TA CZYNNOŚĆ NIE ZAJMIE WIĘCEJ NIŻ 2 MINUTY. SPRAWDŹ CZY PO PRZEKRĘCENIU GAŁKI WYSUWAJĄ SIĘ RYGLE.



ZAINSTALUJ APLIKACJĘ NA SMARTFONIE

- ✓ POBIERZ APLIKACJĘ TEDEE Z APPLE STORE LUB GOOGLE PLAY. ZAREJESTRUJ SIĘ I WŁĄCZ BLUETOOTH, USŁUGĘ LOKALIZACJI I DOSTĘP DO INTERNETU. DODAJ ZAMEK I WPROWADŹ KOD AKTYWACYJNY.



PODŁĄCZ BRIDGE

- ✓ ZNAJDŹ WOLNE GNIAZDKO ZASILANIA, KTÓRE ZNAJDUJE SIĘ NAJBLIŻEJ ZAMKA TEDEE I PODŁĄCZ DO NIEGO BRIDGE. POZWOLI CI TO NA PEŁNĄ KONTROLĘ ZAMKA PRZEZ INTERNET, BEZ ZNACZENIA GDZIE SIĘ ZNAJDUJESZ.

DRZWI DOSTĘPNE OD RĘKI

GERDA®

OPTIMA 60



MILANO 8 NS1



HANOVER NS6

MODEL DRZWI	OPTIMA 60
ROZMIAR	90E
KOLOR	ANTRACYT (FKG), ZŁOTY DĄB (FDE)
OŚCIEŻNICA	PERFOTHERM
SZYBA	MATOWA
PRÓG	ALUMINIOWY
OSPRZĘT	SZYLDY BLOK KLAMKA - KLAMKA Z WKŁADKAMI W KLASIE 5 SYSTEM JED- NEGO KLUCZA (ANODA SREBRNA)

MODEL DRZWI	OPTIMA 60
ROZMIAR	90E
KOLOR	ANTRACYT (FKG), ZŁOTY DĄB (FDE)
OŚCIEŻNICA	PERFOTHERM
SZYBA	MATOWA
PRÓG	ALUMINIOWY
OSPRZĘT	SZYLDY BLOK KLAMKA - KLAMKA Z WKŁADKAMI W KLASIE 5 SYSTEM JED- NEGO KLUCZA (ANODA SREBRNA)

DRZWI ZMONTOWANE (SKRZYDŁO + OŚCIEŻNICA + PRÓG)



TOKIO 2A TMMA

MODEL DRZWI	OPTIMA 60
ROZMIARY	80 90E
KOLOR	ANTRACYT (FKG), ZŁOTY DĄB (FDE)
OŚCIEŻNICA	PERFOTHERM
PRÓG	ALUMINIOWY
OSPRZĘT	SZYLDY BLOK KLAMKA - KLAMKA Z WKŁADKAMI W KLASIE 5 SYSTEM JED- NEGO KLUCZA (ANODA SREBRNA)



PŁASKIE W00

MODEL DRZWI	OPTIMA 60
ROZMIARY	80 90E
KOLOR	ANTRACYT (FKG), ZŁOTY DĄB (FDE)
OŚCIEŻNICA	PERFOTHERM
PRÓG	ALUMINIOWY
OSPRZĘT	SZYLDY BLOK KLAMKA - KLAMKA Z WKŁADKAMI W KLASIE 5 SYSTEM JED- NEGO KLUCZA (ANODA SREBRNA)



DRZWI

Nasze rozwiązania ościeżnic i skrzydeł drzwiowych doskonale sprawdzają się nawet w najbardziej wymagających obiektach. Oferowane przez nas drzwi panelowe i metalowe mogą poszczycić się ponadprzeciętną trwałością, funkcjonalnością (np. możliwością łatwego demontażu i wymiany panela drzwiowego) oraz swobodą aranżacji.



ZAMKI I OKUCIA

Bezpieczeństwo przede wszystkim. Wysoką odporność na włamania uzyskujemy dzięki wewnętrznym odlewom lub płytkom stalowym poddawanych obróbce cieplnej. Hartowana osłona wkładki bębnekowej zabezpiecza ją przed wyrwaniem i uniemożliwia jej przewiercenie.

System klucza generalnego, czyli MASTER KEY to rozwiązanie dedykowane obiektom użytkowym. Przy pomocy jednego klucza można otworzyć określoną liczbę zamknięć. Dzięki temu komunikacja wewnątrz obiektu jest prosta i szybka, a zarządzanie dostęпами do stref i pomieszczeń niezwykle komfortowe.



BRAMY

Wszystkie oferowane przez nas bramy garażowe są zgodne z europejskimi standardami. Bramy GERDA są wyposażone w kompletny system zabezpieczeń, bez jakichkolwiek dopłat.

Seria bram Trend to ekonomiczne, ale trwałe i funkcjonalne rozwiązanie, świetnie sprawdzające się w obiektach deweloperskich.

Bramy z linii Prestige i Prestige Plus gwarantują bardzo dobrą izolację termiczną, między innymi dzięki zastosowaniu ciepłych paneli o grubości 45 mm. Będą doskonałe dla budynków o wysokich wymogach energooszczędności.



STOLARKA ALUMINIOWA

GERDA to również stolarka aluminiowa. Realizujemy ścianki działowe, drzwi, okna, witryny oraz przestrzenne zabudowy wewnętrzne i zewnętrzne, także w wersji przeciwpożarowej i dymoszczelnej oraz o podwyższonej odporności na włamanie.

CO WARTO WIEDZIEĆ O DRZWIACH GERDA

GERDA®

IZOLACJA TERMICZNA

Współczynnik przenikania ciepła (U_d) wskazuje ile energii cieplnej przeniknie przez drzwi (włącznie z ościeżnicą). Na podstawie tego współczynnika możemy określić straty ciepłe osobno dla danej przegrody. Ubytek choćby małej ilości, przekłada się na wyższy rachunek za ogrzewanie. Wartość tego współczynnika zależy od rodzaju i grubości materiału, z którego wykonane są drzwi. Drzwi zewnętrzne firmy Gerda spełniają aktualne normy dzięki zastosowaniu nowoczesnych technologii oraz stalowo-drewnianych i aluminiowych ościeżnic.

Drzwi Gerda, w zależności od zastosowanych komponentów mogą osiągać różne poziomy współczynnika izolacyjności:

- drzwi izolacyjne
- drzwi energooszczędne
- drzwi pasywne

Podstawowe drzwi w ofercie tzw. drzwi izolacyjnych charakteryzują się współczynnikiem poniżej $1,3 \text{ W/m}^2\text{K}$. Zastosowana została tutaj ościeżnica stalowa PERFOOTHERM® z perforacją termiczną, uszczelką i progim. Drzwi energooszczędne Optima 60 i Thermo Premium 60, posiadają współczynnik od $0,9 \text{ W/m}^2\text{K}$ w przypadku zastosowania

(cieplej ościeżnicy aluminiowej ALUTHERM z wypełnieniem komory termicznej i uszczelką) oraz $1,0 \text{ W/m}^2\text{K}$ przy zastosowaniu ościeżnicy DUOTHERM (cieplej ościeżnicy stalowo-drewnianej z perforacją termiczną i uszczelką).

Drzwi pasywne to drzwi, których celem jest przede wszystkim maksymalna oszczędność energii przy jednoczesnym podniesieniu komfortu mieszkania. Pozwalają gromadzić energię wewnątrz pomieszczenia, co prowadzi do bezpośredniej oszczędności. Drzwi Thermo Premium 75, charakteryzują się współczynnikiem przenikania od $0,79 \text{ W/m}^2\text{K}$. Współczynnik przenikalności cieplnej dotyczy drzwi pełnych przy zastosowaniu ciepłej ościeżnicy aluminiowej ALUTHERM.



BRAK IZOLACJI

$1,5 \text{ W/m}^2\text{K}$

**$1,3 \text{ W/m}^2\text{K}$
CZYSZTE
POWIETRZE**

$1,0 \text{ W/m}^2\text{K}$

ODPORNOŚĆ NA WŁAMANIE

To parametr, który określa drzwi potocznie zwane antywłamaniowymi. Takie drzwi posiadają specjalną, solidną konstrukcję mającą m.in. na celu znaczne utrudnienie wycięcia w nich otworu, zapobiegając nieuprawnionemu wejściu. Drzwi GERDA standardowo wyposażone są w dwa solidne zamki z wielopunktowym systemem ryglowania. Istotnym elementem są bolce antywyważeniowe, których zadaniem jest niedopuszczenie do wyważenia skrzydła drzwi lub zdjęcia ich z zawiasów. Drzwi GERDA przechodzą badania odporności na włamanie i legitymują się klasami odporności na włamanie od RC2/RC3 do RC3. Zastosowanie drzwi w wyższej klasie, zwiększa poziom bezpieczeństwa osób i mienia w domu.



KLASY ANTYWŁAMANIOWOŚCI

KLASA RC2



SZCZYPCE



KLIN



MŁOTEK

KLASA RC3



STALOWY ŁOM



KLIN



MŁOTEK



MECHANICZNA WIERTARKA

KLASA RC4



CIEŻKI MŁOTEK



SIEKIERA



PRZECINAK



DŁUTO



WIERTARKA

GERDA

O CZYM PAMIĘTAĆ WYBIERAJĄC DRZWI GERDA

1

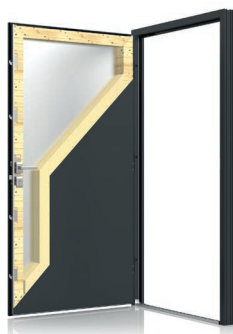

**ZDECYDUJ O RODZAJU KONSTRUKCJI
NAJLEPIEJ DOSTOSOWANEJ DO TWOICH
POTRZEB**

2



**WYBIERZ WZÓR DRZWI Z NASZEJ
SZEROKIEJ KOLEKCJI PROJEKTÓW**

3

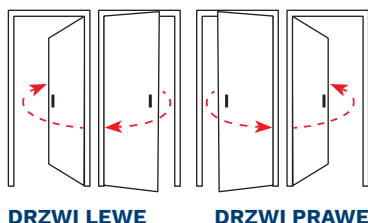

**SPRAWDŹ DOSTĘPNE
SZEROKOŚCI I ZDECYDUJ**

4



**CIESZ SIĘ MOŻLIWOŚCIĄ INDYWIDUALNEGO
PROJEKTOWANIA WYBIERAJĄC WZÓR
OKLEINY DRZWI I WZÓR APLIKACJI**

5

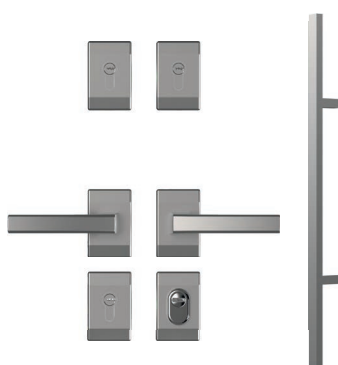

**WYBIERZ OPCJONALNIE WYPOSAŻENIE
DODATKOWE: DOŚWIELTA, KLAMKI,
POCHWYTY, OŚCIEŻNICE**

**KOLEKCJA
DRZWI GERDA**

ERDA®

PRODUKT KLASY PREMIUM



**MILANO 8
WINCHESTER**

**VILLACH
STALOWOSZARY**

**INNSBRUCK
JASNY ORZECH**

GERDA®

KOLEKCJA DRZWI GERDA

PRODUKT KLASY PREMIUM

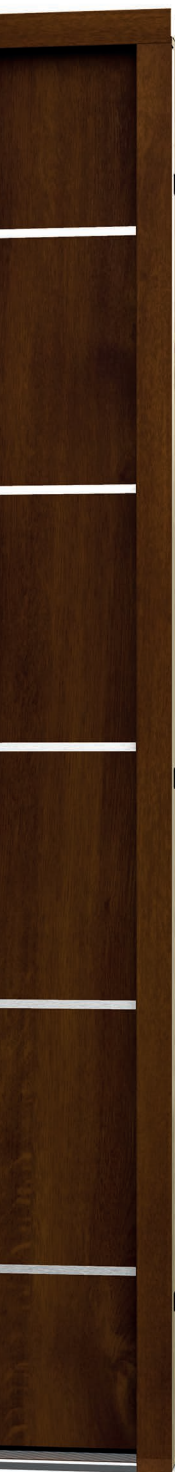

REGEN 5
CIEMNY ANTRACYT









BAMBERG 3
DĄB TURNER

GERDA **PRDA**[®] THERMO PRIME 75



CHARAKTERYSTYKA

	IZOLACJA TERMICZNA	PEŁNE / PRZESZKLONE OŚCIEŻNICA ALUTHERM PRIME 0,79 W/m²K / 0,9 W/m²K
	KLASA ANTYWŁAMANIOWOŚCI	RC2
	GRUBOŚĆ SKRZYDŁA	75 mm
	ROZMIARY DRZWI	80, 90N, 90E, 100E*
	LINIE WZORNICZE	4
	KONSTRUKCJA SKRZYDŁA	RAMIAK Z DREWNA + PIANA PUR
	NIESTANDARDOWY ROZMIAR DRZWI	WYSOKOŚĆ DRZWI DO 2400 mm

* DOPLATA

DRZWI PEŁNE / PRZESZKLONE
OŚCIEŻNICA ALUTHERM PRIME

UD = 0,79 / 0,9 W/m²K

DRZWI PEŁNE / PRZESZKLONE
OŚCIEŻNICA STAŁOWA

-

RC2

od 4487 zł

OŚCIEŻNICA ALUTHERM PRIME



REGULOWANE ZACZEPY HAKÓW

Regulowane zaczepy haków z elastyczną wkładką teflonową.



PRZEGRODA TERMICZNA



ZAWIAS 3D Z NASADKAMI

Regulowane w trzech płaszczyznach, nasadki w kolorze okuć



GRUBOŚĆ DRZWI



ZAMEK LISTWOWY 5 PUNKTOWY

Montaż zamka na całej wysokości skrzydła.



SZYLD PIERŚCIENIOWY

Dostępny w komplecie z pochwytem



CIEPŁY PRÓG ALUMINIOWY Z ŁĄCZNIKIEM

OŚCIEŻNICA ALUTHERM PRIME

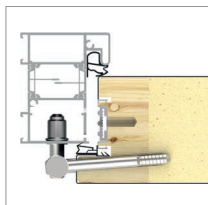

PRÓG



REGULOWANY ZACZEP ZAPADKI

Umożliwia płynną regulację docisku skrzydła do uszczelek.



BOLCE ANTYWYWAŻENIOWE

Stale bolce przeciwyważeniowe w metalowych wspornikach.



PRZYLGĄ DOLNA, USZCZELKA SZCZOTKOWA PRIME

LEGENDA

* CENA NETTO OBEJMUJE SKRZYDŁO, PRÓG, OŚCIEŻNICĘ I KLAMKI Z WKŁADKAMI W KLASIE 5 ORAZ ZESTAWEM MONTAŻOWYM.



■ Dopłata

GERDA THERMO PREMIUM 75

GERDA®



CHARAKTERYSTYKA

	IZOLACJA TERMICZNA	PEŁNE / PRZESZKLONE OŚCIEŻNICA DUOTHERM 0,9 W/m ² K / 1,3 W/M ² K	PEŁNE / PRZESZKLONE OŚCIEŻNICA ALUTHERM PREMIUM 0,8 W/m ² K / 1,1 W/m ² K
	KLASA ANTYWŁAMANIOWOŚCI		RC2 / RC3*
	GRUBOŚĆ SKRZYDŁA		75 mm
	ROZMIARY DRZWI		80, 90N, 90E, 100E**
	LINIE WZORNICZE		4
	KONSTRUKCJA SKRZYDŁA	RAMIAK Z DREWNA + EKSPANDOWANY POLISTYREN GRAFITOWY	

* TYLKO DRZWI PEŁNE, DOPŁATA
** DOPŁATA

**DRZWI PEŁNE / PRZESZKLONE
OŚCIEŻNICA
ALUTHERM PREMIUM**

UD = 0,8 / 1,1 W/m²K

**DRZWI PEŁNE / PRZESZKLONE
OŚCIEŻNICA DUOTHERM**

UD = 0,9 / 1,3 W/m²K

RC2/RC3

od 3019 zł



RYGIEL PIONOWY

Antywłamaniowy rygiel pionowy sterowany z zamka głównego dla RC3

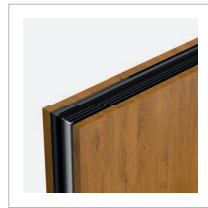

PRZEGRODA TERMICZNA

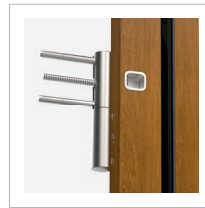

ZAWIAS 3D Z NASADKAMI

Regulowane w trzech płaszczyznach, nasadki w kolorze okuć



GRUBOŚĆ DRZWI

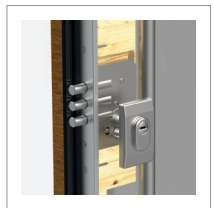

ZAMEK DODATKOWY

3-ryglowy klasy 6
GERDA ZW 500



ZAMEK GŁÓWNY

Zamek centralny
3-ryglowy klasy 7 GERDA ZW 2000



ZAMEK POMOCNICZY

2-ryglowy

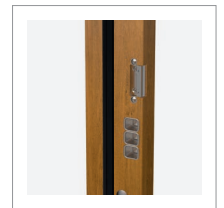

**REGULOWANY
ZACZEP ZAPADKI**

Umożliwia płynną regulację docisku skrzydła do uszczelek.

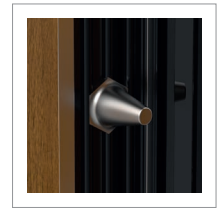

BOLCE ANTYWYWAŻENIOWE

Stale bolce przeciwyważeniowe w metalowych wspornikach.

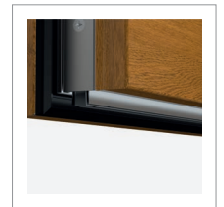

**PRZYLGA DOLNA,
USZCZELKA SZCZOTKOWA**

**OŚCIEŻNICA
ALUTHERM PREMIUM**

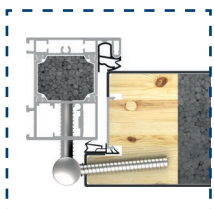

**OŚCIEŻNICA
DUOTHERM**



PRÓG

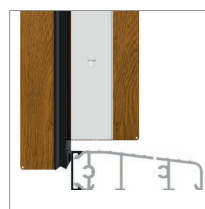

LEGENDA





* CENA NETTO OBEJMUJE SKRZYDŁO, PRÓG, OŚCIEŻNICĘ I KLAMKI Z WKŁADKAMI W KLASIE 5 ORAZ ZESTAWEM MONTAŻOWYM.

■ Dopłata

GERDA THERMO PREMIUM 60



CHARAKTERYSTYKA

 UD	IZOLACJA TERMICZNA	PEŁNE / PRZESZKLONE OŚCIEŻNICA DUOTHERM 1,0 W/m ² K / 1,3 W/m ² K	PEŁNE / PRZESZKLONE OŚCIEŻNICA ALUTHERM PREMIUM 0,9 W/m ² K / 1,2 W/m ² K
 RC	KLASA ANTYWŁAMANIOWOŚCI		RC2 / RC3*
 $\left\langle \right\rangle$ mm	GRUBOŚĆ SKRZYDŁA		60 mm
	ROZMIARY DRZWI		80, 90N, 90E, 100E*
 G	LINIE WZORNICZE		4
	KONSTRUKCJA SKRZYDŁA	RAMIAK Z DREWNA + EKSPANDOWANY POLISTYREN GRAFITOWY	

* TYLKO DRZWI PEŁNE, DOPŁATA

** DOPŁATA

DRZWI PEŁNE / PRZESZKLONE
OŚCIEŻNICA
ALUTHERM PREMIUM

UD = 0,9 / 1,2 W/m²K

DRZWI PEŁNE / PRZESZKLONE
OŚCIEŻNICA DUOTHERM

UD = 1,0 / 1,3 W/m²K

RC2/RC3

od 2587 zł



RYGIEL PIONOWY

Antywłamaniowy rygiel pionowy sterowany z zamka głównego dla RC3

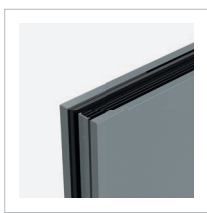

PRZEGRODA TERMICZNA



ZAWIAS 3D Z NASADKAMI

Regulowane w trzech płaszczyznach, nasadki w kolorze okuć



GRUBOŚĆ DRZWI



ZAMEK DODATKOWY

3-ryglowy klasy 6
GERDA ZW500



ZAMEK GŁÓWNY

3-ryglowy klasy 7 GERDA ZW1000,
dla RC3 zamek centralny ZW2000



ZAMEK POMOCNICZY

2-ryglowy dla RC3

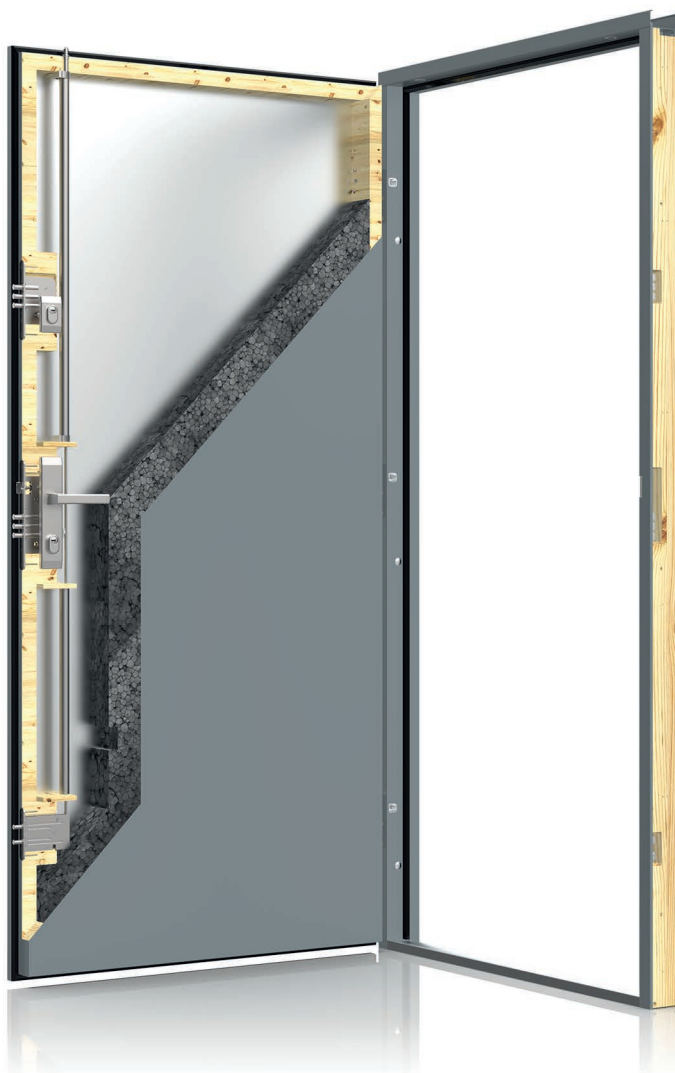

REGULOWANY ZACZEP ZAPADKI

Umożliwia płynną regulację docisku skrzydła do uszczelek.



BOLCE ANTYWYWAŻENIOWE

Stale bolce przeciwyważeniowe w metalowych wspornikach.



PRZYLGA DOLNA, USZCZELKA SZCZOTKOWA

OŚCIEŻNICA ALUTHERM PREMIUM

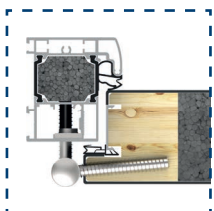

OŚCIEŻNICA DUOTHERM

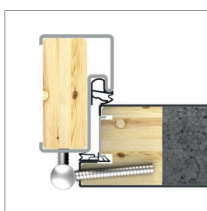

PRÓG

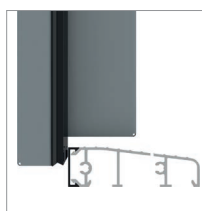

LEGENDA

* CENA NETTO OBEJMUJE SKRZYDŁO, PRÓG, OŚCIEŻNICE I KLAMKI Z WKŁADKAMI W KLASIE 5 ORAZ ZESTAWEM MONTAŻOWYM.

■ Dopłata

AIR GLASS



AGB LINZ 1 S. 26



AGC LINZ 2 S. 26



AGD LINZ 3 S. 26



AGDB LINZ 3 B S. 26



AGE GRAZ 1 S. 28



AGF GRAZ 2 S. 28

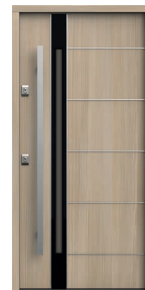

AGG GRAZ 3 S. 29

QUADRO



KWA PASAWA 1 S. 32



KWB PASAWA 2 S. 32



KWC PASAWA 3 S. 33



KWD PASAWA 4 S. 33



KWE JENA 3 S. 34



KW4 JENA 4 S. 34



KWF BAMBERG 1 S. 36



KWN TREWIR 3 S. 41



KWP TREWIR 4 S. 41



KW7 TREWIR 7 S. 41



KWS DORFEN S. 42



KWT KASSEL 1 S. 44



KWX KASSEL 2 S. 44



KPN KRONACH 1 S. 46



KPM REGEN 5 S. 49



KPR REGEN 6 S. 49



KPRB REGEN 6 B S. 49



KPE DREZNO 1 S. 50



KPF DREZNO 2 S. 50



KPH DREZNO 4 S. 51



KPA ERFURT 1 S. 52

ELITE 3D



ELA BRIG S. 54



ELB OLTEN S. 54



ELC VISP S. 55



ELD TRIN S. 55



ELE BERNO S. 55

TEMPO



NS1 MILANO 8 S. 56



NS2 MILANO 9 S. 56



AGGB GRAZ 3 B S. 29



AGA SALZBURG S. 30



AGH VILLACH S. 30



AGHB VILLACH B S. 30



KWG BAMBERG 2 S. 36



KWH BAMBERG 3 S. 37



KWI BAMBERG 4 S. 37



KWJ ULM 1 S. 38



KWK ULM 2 S. 38



KWL TREWIR 1 S. 40



KWM TREWIR 2 S. 40



KPP KRONACH 2 S. 46



KPT KRONACH 3 S. 47



KPZ KRONACH 4 S. 47



KPJ REGEN 1 S. 48



KPK REGEN 2 S. 48



KPL REGEN 3 S. 49



KPS REGEN 4 S. 49



KPB ERFURT 2 S. 52



KPC ERFURT 3 S. 53



NS3 MILANO 10 S. 57



NS4 MILANO 11 S. 57



NS9B MILANO 12 B S. 57



NSSB HANOVER 5 B S. 58



NS6 HANOVER 6 S. 58



NS7 INNSBRUCK S. 59



W00 PŁASKIE S. 60



CHARAKTERYSTYKA

UD	IZOLACJA TERMICZNA	PEŁNE / PRZESZKLONE OŚCIEŻNICA PERFOTHERM 1,1 W/m²K / 1,3 W/m²K	PEŁNE / PRZESZKLONE OŚCIEŻNICA ALUTHERM OPTIMA 1,0 W/m²K / 1,3 W/m²K
RC	KLASA ANTYWŁAMANIOWOŚCI		RC2 / RC3*
	GRUBOŚĆ SKRZYDŁA		60 mm
	ROZMIARY DRZWI		80N, 80, 90N, 90E, 100E**
	LINIE WZORNICZE		2
	KONSTRUKCJA SKRZYDŁA	KLOCKI DREWNIANE + RAMIAK DREWNIANY + EKSPANDOWANY POLISTYREN GRAFITOWY	

* TYLKO DRZWI PEŁNE, DOPŁATA
** DOPŁATA

DRZWI PEŁNE / PRZESZKLONE
OŚCIEŻNICA
ALUTHERM OPTIMA

UD = 1,0 / 1,3 W/m²K

DRZWI PEŁNE / PRZESZKLONE
OŚCIEŻNICA PERFOTHERM

UD = 1,1 / 1,3 W/m²K

RC2/RC3

od 2155 zł



RYGIEL PIONOWY

Antywłamaniowy rygiel pionowy sterowany z zamka głównego dla RC3

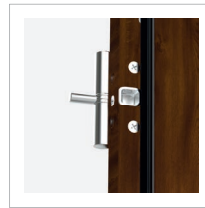

ZAWIAS 2D Z NASADKAMI

W kolorze okuć



GRUBOŚĆ DRZWI

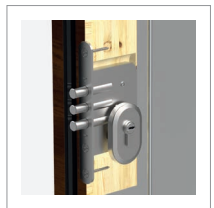

ZAMEK DODATKOWY

3-ryglowy klasy 6
GERDA ZW500



ZAMEK GŁÓWNY

3-ryglowy klasy 7 GERDA ZW1000,
dla RC3 zamek centralny ZW2000

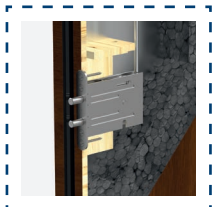

ZAMEK POMOCNICZY

2-ryglowy dla RC3

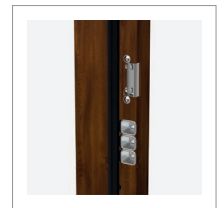

REGULOWANY ZACZEP ZAPADKI

Umożliwia płynną regulację docisku skrzydła do uszczelek.



BOLCE ANTYWYWAŻENIOWE

Stale bolce przeciwwyważeniowe w metalowych wspornikach.



OŚCIEŻNICA
ALUTHERM OPTIMA

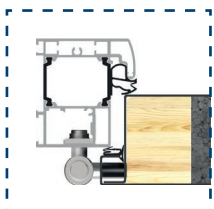

OŚCIEŻNICA
PERFOTHERM



PRÓG

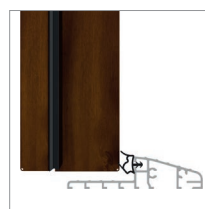







LEGENDA

* CENA NETTO OBEJMUJE SKRZYDŁO, PRÓG, OŚCIEŻNICE I KLAMKI Z WKŁADKAMI W KLASIE 5 ORAZ ZESTAWEM MONTAŻOWYM.

— — Dopłata



CHARAKTERYSTYKA

	IZOLACJA TERMICZNA	PEŁNE OŚCIEŻNICA PERFOTHERM 1,2 W/m²K
	KLASA ANTYWŁAMANIOWOŚCI	RC2
	GRUBOŚĆ SKRZYDŁA	50 mm
	ROZMIARY DRZWI	80N, 80, 90N, 90E, 100E*
	LINIE WZORNICZE	2
	KONSTRUKCJA SKRZYDŁA	KŁOCKI DREWNIANE + RAMIAK + EKSPANDOWANY POLISTYREN GRAFITOWY

* DOPLATA

DRZWI PEŁNE / PRZESZKLONE
OŚCIEŻNICA ALUMINIOWA

-

DRZWI PEŁNE
OŚCIEŻNICA PERFOTHERM

UD = 1,2 W/m²K

RC2

od 1809 zł

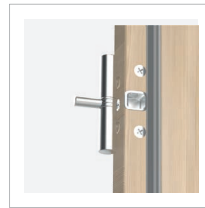

ZAWIAS 2D Z NASADKAMI

W kolorze okuć



GRUBOŚĆ DRZWI

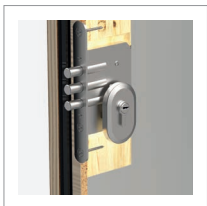

ZAMEK DODATKOWY

3-ryglowy klasy 6
GERDA ZW 500

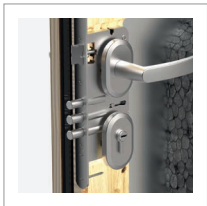

ZAMEK GŁÓWNY

3-ryglowy klasy 7
GERDA ZW 1000



**REGULOWANY
ZACZEP ZAPADKI**

Umożliwia płynną regulację
docisku skrzydła do uszczelek.

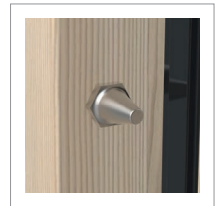

BOLCE ANTYWYWAŻENIOWE

Stale bolce przeciwyważeniowe
w metalowych wspornikach.



OŚCIEŻNICA
PERFOTHERM

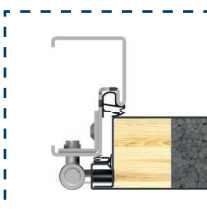

OŚCIEŻNICA
FB

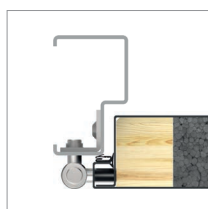

OŚCIEŻNICA
FN

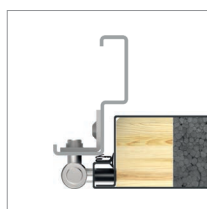

PRÓG

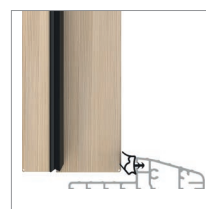

LEGENDA

* CENA NETTO OBEJMUJE SKRZYDŁO, PRÓG, OŚCIEŻNICE I KLAMKI Z WKŁADKAMI W KLASIE 5 ORAZ ZESTAWEM MONTAŻOWYM.

■ Dopłata

* MOŻLIWOŚĆ UŻYCIA PRÓGU DREWNIANEGO

TEMPO



NS1 MILANO 8 S. 56



NS2 MILANO 9 S. 56



NS3 MILANO 10 S. 57



NS4 MILANO 11 S. 57



NS9 MILANO 12 S. 57



NS9B MILANO 12 B S. 57



NS5 HANOVER 5 S. 58



NT1 TURYN 1 S. 64



NT2 TURYN 2 S. 65



SOJ BERGAMO 2 S. 66



SJ9 NICEA 9 S. 66



SBE BERLIN 4 S. 67



ST4 UPPSALA 1 S. 68



ST4A UPPSALA 1A S. 68



ST9 LUND S. 72



WBA ASPEN 1 S. 73



TN7 ASPEN 2 S. 73



TN7B ASPEN 2B S. 73



SR3 TROMSO S. 74

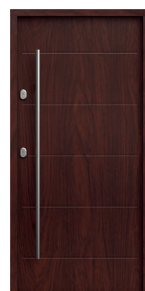

SR4 TROMSO 1 S. 74



SR5 TROMSO 2 S. 75

CLASSIC



W76 MODENA S. 76



W77 MODENA 2 S. 76



W78 MODENA 3 S. 77



WDR RAVENA S. 77



WJ1 NICEA 5 S. 78



W23 OLYMPIA S. 79



W91 WERONA S. 80



W24 LIZBONA S. 82



W9N WENECJA S. 82



W13 LONDYN S. 83



W5L LONDYN 1 S. 83



W54 BARCELONA S. 84



W53 BARCELONA 1 S. 84



G76 GENEWA 1 S. 85



NS5B HANOVER 5 B S. 58



NS6 HANOVER 6 S. 58



NS7 INNSBRUCK S. 59



W00 PŁASKIE S. 60



W00 PŁASKIE S. 60



SNU MILANO 4 S. 62



SNUA MILANO 4A S. 62



ST5 UPPSALA 2 S. 69



ST5A UPPSALA 2A S. 69



TML TOKIO 1 S. 70



TMLA TOKIO 1A S. 70



TMM TOKIO 2 S. 71



TMMa TOKIO 2A S. 71



ST8 RYGA S. 72



SR5 TROMSO 2 S. 75



W94 WERONA 1 S. 80



W93 WERONA 3 S. 81



W6A WERONA 4 S. 81



WQA WERONA 5 S. 81



G75 GENEWA 2 S. 85



D75 GENEWA 3 S. 85



AGB LINZ 1



AGC LINZ 2

ROZMIAR	80	90N	90E	100E
---------	----	-----	-----	------

MODEL	THERMO PREMIUM 60	THERMO PREMIUM 75	THERMO PRIME 75
AGB / AGBB LINZ 1	4 677 Zł	5 109 Zł	6 577 Zł
AGC / AGCB LINZ 2	4 677 Zł	5 109 Zł	6 577 Zł
AGD / AGDB LINZ 3	4 842 Zł	5 274 Zł	6 742 Zł

WYPOSAŻENIE STANDARDOWE RC2

- SKRZYDŁO PRZESZKLONE SPEŁNIAJĄCE WARUNKI PROGRAMU CZYSTE POWIETRZE
- 4 PRZYLGI SKRZYDŁA
- THERMO PREMIUM OŚCIEŻNICA DUOTHERM / THERMO PRIME OŚCIEŻNICA ALUTHERM PRIME
- ZAWIASY REGULOWANE 3D Z OSŁONKAMI W KOLORZE OKUĆ
- CIEPLY PRÓG
- KOMPLET OKUĆ Z OCHRONĄ WKŁADKI
- SZYLDY BERGEN Z KLAMKAMI ALEX
- WKŁADKI W KLASIE 5, SYSTEM JEDNEGO KLUCZA DLA DRZWI THERMO PREMIUM

• INSERTY **INOX** **BLACK**

DOPLATY

OŚCIEŻNICA ALUTHERM PREMIUM (DRZWI THERMO PREMIUM)	950 Zł	ELEKTROZACZEP Z FUNKCJĄ DZIEŃ / NOC	250 Zł
DRZWI DWUKOLOROWE	500 Zł	1800 mm	825 Zł
WKŁADKI W KLASIE 6 W SYSTEMIE JEDNEGO KLUCZA	180 Zł	1700 mm	800 Zł
OCHRONA GÓRNEGO SZYLDU (THERMO PREMIUM)	30 Zł	1500 mm	770 Zł
KLAMKO - GAŁKA	50 Zł	1000 mm	715 Zł
KONTAKTRON	120 Zł	1800 mm	1 640 Zł
ROZMIAR 100E	350 Zł	1700 mm	1 620 Zł
		1500 mm	1 590 Zł
		1000 mm	1 540 Zł
		ZESTAW TEDEE	1 650 Zł

* DOŚWIETLA ALUMINIOWE STAŁE: STRONY 88-89, PEŁNA LISTA WYPOSAŻENIA: STRONY 94-99

SZYBA



GRAFIT

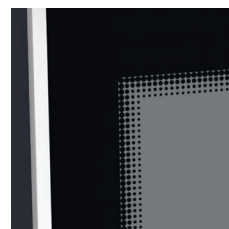

INOX



BLACK

KOLORY DRZWI

ORZECH ALPEJSKI



FRR

MAHOŃ



FMA

ORZECH BRAZYLJSKI



FRB

JASNY ORZECH



FRP

ZŁOTY DĄB



FDE

WINCHESTER



FDW

DĄB TURNER



FDT

JASNY WENGE



FEJ

BIAŁY

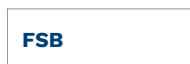

FSB

STALOWOSZARY



FKZ

ANTRACYT



FKG

CIEMNY ANTRACYT



FKF

CZARNY



FKC



AGD LINZ 3



STRONA WEWNĘTRZNA

KONFIGURACJA DRZWI THERMO PRIME 75



AGDB LINZ 3 B



STRONA WEWNĘTRZNA

OKUCIA KLAMKA-KLAMKA



THERMO PRIME



THERMO PREMIUM

KLAMKA-GAŁKA



THERMO PRIME



THERMO PREMIUM

POCHWYT

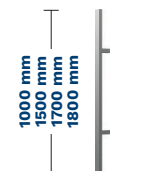

- AMSTERDAM
- MONTREAL

KOLORY OKUĆ

ANODA PLATYNA



ANODA SREBRNA



ANODA CZARNA



KOLORY DRZWI

ORZECH ALPEJSKI



MAHOŃ



ORZECH BRAZYLIJSKI



JASNY ORZECH



ZŁOTY DĄB



WINCHESTER



DĄB TURNER



JASNY WENGE



BIAŁY



STALOWOSZARY



ANTRACYT



CIEMNY ANTRACYT



CZARNY





AGE GRAZ 1



AGF GRAZ 2

ROZMIAR

	80	90N	90E	100E
--	----	-----	-----	------

MODEL

	THERMO PREMIUM 60	THERMO PREMIUM 75	THERMO PRIME 75
AGE / AGEB GRAZ 1	4 677 Zł	5 109 Zł	6 577 Zł
AGF / AGFB GRAZ 2	4 677 Zł	5 109 Zł	6 577 Zł
AGG / AGGB GRAZ 3	4 842 Zł	5 274 Zł	6 742 Zł

WYPOSAŻENIE STANDARDOWE RC2

- SKRZYDŁO PRZESZKŁONE SPEŁNIAJĄCE WARUNKI PROGRAMU CZYSTE POWIETRZE
- 4 PRZYLGI SKRZYDŁA
- THERMO PREMIUM OŚCIEŻNICA DUOTHERM / THERMO PRIME OŚCIEŻNICA ALUTHERM PRIME
- ZAWIASY REGULOWANE 3D Z OSŁONKAMI W KOLORZE OKUĆ
- CIEPLY PRÓG
- KOMPLET OKUĆ Z OCHRONĄ WKŁADKI
- SZYLDY BERGEN Z KLAMKAMI ALEX
- WKŁADKI W KLASIE 5, SYSTEM JEDNEGO KLUCZA DLA DRZWI THERMO PREMIUM

INSERTY

INOX

BLACK

DOPLATY

OŚCIEŻNICA ALUTHERM PREMIUM (DRZWI THERMO PREMIUM)	950 Zł	ELEKTROZACZEP Z FUNKCJĄ DZIEŃ / NOC	250 Zł
DRZWI DWUKOLOROWE	500 Zł	1800 mm	825 Zł
WKŁADKI W KLASIE 6 W SYSTEMIE JEDNEGO KLUCZA	180 Zł	1700 mm	800 Zł
		1500 mm	770 Zł
		1000 mm	715 Zł
OCHRONA GÓRNEGO SZYLDU (THERMO PREMIUM)	30 Zł	1800 mm	1 640 Zł
KLAMKO - GAŁKA	50 Zł	1700 mm	1 620 Zł
KONTAKTRON	120 Zł	1500 mm	1 590 Zł
ROZMIAR 100E	350 Zł	1000 mm	1 540 Zł
		ZESTAW TEDEE	1 650 Zł

* DOŚWIETLA ALUMINIOWE STAŁE: STRONY 88-89, PEŁNA LISTA WYPOSAŻENIA: STRONY 94-99

SZYBA



GRAFIT

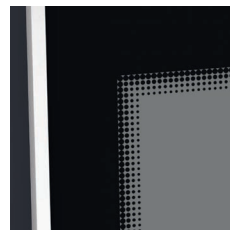

INOX



BLACK

KOLORY DRZWI

ORZECH ALPEJSKI



FRR

MAHOŃ



FMA

ORZECH BRAZYLJSKI



FRB

JASNY ORZECH



FRP

ZŁOTY DĄB



FDE

WINCHESTER



FDW

DĄB TURNER



FDT

JASNY WENGE



FEJ

BIAŁY



FSB

STALOWOSZARY



FKZ

ANTRACYT



FKG

CIEMNY ANTRACYT



FKF

CZARNY



FKC



AGGB GRAZ 3 B



STRONA WEWNĘTRZNA

KONFIGURACJA DRZWI THERMO PRIME 75



AGF GRAZ 2



STRONA WEWNĘTRZNA

OKUCIA KLAMKA-KLAMKA



THERMO PRIME



THERMO PREMIUM

KLAMKA-GAŁKA



THERMO PRIME



THERMO PREMIUM

POCHWYT

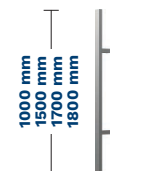

- AMSTERDAM
- MONTREAL

KOLORY OKUĆ

ANODA PLATYNA



ANODA SREBRNA



ANODA CZARNA



KOLORY DRZWI

ORZECH ALPEJSKI



MAHOŃ



ORZECH BRAZYLIIJSKI



JASNY ORZECH



ZŁOTY DĄB



WINCHESTER



DĄB TURNER



JASNY WENGE



BIAŁY



STALOWOSZARY



ANTRACYT



CIEMNY ANTRACYT



CZARNY



AIR GLASS SALZBURG / VILLACH



AGA SALZBURG



AGHB VILLACH B

ROZMIAR (AGA SALZBURG)	80	90N	90E	100E
ROZMIAR (AGH VILLACH)	-	-	90E	100E

MODEL	THERMO PREMIUM 60	THERMO PREMIUM 75	THERMO PRIME 75
AGA / AGAB SALZBURG	5 007 Zł	5 439 Zł	6 907 Zł
AGH / AGHB VILLACH	5 007 Zł	5 439 Zł	6 907 Zł

WYPOSAŻENIE STANDARDOWE RC2

- SKRZYDŁO PRZESZKLONE SPEŁNIAJĄCE WARUNKI PROGRAMU CZYSTE POWIETRZE
- 4 PRZYLGI SKRZYDŁA
- THERMO PREMIUM OŚCIEŻNICA DUOTHERM / THERMO PRIME OŚCIEŻNICA ALUTHERM PRIME
- ZAWIASY REGULOWANE 3D Z OSŁONKAMI W KOLORZE OKUĆ
- CIEPLY PRÓG
- KOMPLET OKUĆ Z OCHRONĄ WKŁADKI
- SZYLDY BERGEN Z KLAMKAMI ALEX
- WKŁADKI W KLASIE 5, SYSTEM JEDNEGO KLUCZA DLA DRZWI THERMO PREMIUM

- INSERTY **INOX** **BLACK**

DOPLĄTY

WYSOKOŚĆ NIESTANDARDOWA (THERMO PRIME)	2150 - 2200 mm	330 ZŁ
TYLKO WZÓR AGH / AGHB	2250 - 2300 mm	680 ZŁ
DOSTĘPNE KOLORY: FRP, FDE, FDW, FKG, FKF	2350 - 2400 mm	1100 ZŁ
OŚCIEŻNICA ALUTHERM PREMIUM (DRZWI THERMO PREMIUM)	950 ZŁ	ELEKTROZACZEP Z FUNKCJĄ DZIEN / NOC 250 ZŁ
DRZWI DWUKOLOROWE	500 ZŁ	1800 mm 825 ZŁ
WKŁADKI W KLASIE 6 W SYSTEMIE JEDNEGO KLUCZA	180 ZŁ	POCHWYT AMSTERDAM / MONTREAL ZALECANY ELEKTROZACZEP
OCHRONA GÓRNEGO SZYLDU (THERMO PREMIUM)	30 ZŁ	1700 mm 800 ZŁ
KLAMKO - GAŁKA	50 ZŁ	1500 mm 770 ZŁ
KONTAKTRON	120 ZŁ	1000 mm 715 ZŁ
ROZMIAR 100E	350 ZŁ	1800 mm 1 640 ZŁ
		1700 mm 1 620 ZŁ
		1500 mm 1 590 ZŁ
		1000 mm 1 540 ZŁ
		ZESTAW TEDEE 1 650 ZŁ

* DOŚWIELTA ALUMINIOWE STAŁE: STRONY 88-89, PEŁNA LISTA WYPOSAŻENIA: STRONY 94-99

SZYBA



GRAFIT

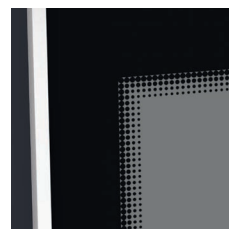

INOX



BLACK

KOLORY DRZWI

ORZECH ALPEJSKI



FRR

MAHOŃ



FMA

ORZECH BRAZYLJSKI

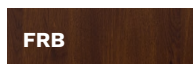

FRB

JASNY ORZECH



FRP

ZŁOTY DĄB



FDE

WINCHESTER



FDW

DĄB TURNER



FDT

JASNY WENGE



FEJ

BIAŁY

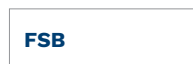

FSB

STALOWOSZARY



FKZ

ANTRACYT



FKG

CIEMNY ANTRACYT



FKF

CZARNY



FKC



AGA SALZBURG

KONFIGURACJA DRZWI THERMO PRIME 75



STRONA WEWNĘTRZNA

STRONA WEWNĘTRZNA

OKUCIA

KLAMKA-KLAMKA



THERMO PRIME



THERMO PREMIUM

KLAMKA-GAŁKA



THERMO PRIME



THERMO PREMIUM

POCHWYT

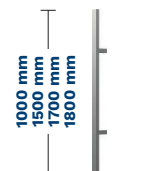

□ AMSTERDAM
○ MONTREAL

KOLORY OKUĆ

ANODA PLATYNA



ANODA SREBRNA



ANODA CZARNA



KOLORY DRZWI

ORZECH ALPEJSKI



MAHOŃ



ORZECH BRAZYLIIJSKI



JASNY ORZECH



ZŁOTY DĄB



WINCHESTER



DĄB TURNER



JASNY WENGE



BIAŁY



STALOWOSZARY



ANTRACYT



CIEMNY ANTRACYT



CZARNY





KWA PASAWA 1



KWB PASAWA 2

KOLORY DRZWI

ORZECH ALPEJSKI



FRR

MAHOŃ



FMA

ORZECH BRAZYLIJSKI



FRB

JASNY ORZECH



FRP

ZŁOTY DĄB



FDE

WINCHESTER



FDW

DĄB TURNER



FDT

JASNY WENGE



FEJ

BIAŁY



FSB

STALOWOSZARY



FKZ

ANTRACYT



FKG

CIEMNY ANTRACYT



FKF

CZARNY



FKC

ROZMIAR

	80	90N	90E	100E
--	----	-----	-----	------

MODEL

	THERMO PREMIUM 60	THERMO PREMIUM 75	THERMO PRIME 75
KWA / KWAB PASAWA 1	5 117 Zł	5 545 Zł	7 017 Zł
KWB / KWBB PASAWA 2	4 952 Zł	5 384 Zł	6 852 Zł
KWC / KWCB PASAWA 3	4 952 Zł	5 384 Zł	6 852 Zł
KWD / KWDB PASAWA 4	4 787 Zł	5 219 Zł	6 687 Zł

WYPOSAŻENIE STANDARDOWE RC2

- SKRZYDŁO PRZESZKLONE SPEŁNIAJĄCE WARUNKI PROGRAMU CZYSTE POWIETRZE
- 4 PRZYLGI SKRZYDŁA
- THERMO PREMIUM OŚCIEŻNICA DUOTHERM / THERMO PRIME OŚCIEŻNICA ALUTHERM PRIME
- ZAWIASY REGULOWANE 3D Z OSŁONKAMI W KOLORZE OKUĆ
- CIEPLY PRÓG
- KOMPLET OKUĆ Z OCHRONĄ WKŁADKI
- SZYLDY BERGEN Z KLAMKAMI ALEX
- WKŁADKI W KLASIE 5, SYSTEM JEDNEGO KLUCZA DLA DRZWI THERMO PREMIUM

• INSERTY

INOX

BLACK

DOPLATY

WYSOKOŚĆ NIESTANDARDOWA (THERMO PRIME) DOSTĘPNE KOLORY: FRP, FDE, FDW, FKG, FKF	2150 – 2200 mm	330 ZŁ
	2250 – 2300 mm	680 ZŁ
	2350 – 2400 mm	1100 ZŁ
OŚCIEŻNICA ALUTHERM PREMIUM (DRZWI THERMO PREMIUM)	1800 mm	825 ZŁ
	1700 mm	800 ZŁ
	1500 mm	770 ZŁ
DRZWI DWUKOLOROWE	1000 mm	715 ZŁ
	1800 mm	1 640 ZŁ
WKŁADKI W KLASIE 6 W SYSTEMIE JEDNEGO KLUCZA	1700 mm	1 620 ZŁ
	1500 mm	1 590 ZŁ
OCHRONA GÓRNEGO SZYLDU (THERMO PREMIUM)	1000 mm	1 540 ZŁ
	1800 mm	1 640 ZŁ
KŁAMKO - GAŁKA	1700 mm	1 620 ZŁ
	1500 mm	1 590 ZŁ
KONTAKTRON	1000 mm	1 540 ZŁ
	1800 mm	1 640 ZŁ
ROZMIAR 100E	SKRACANIE DRZWI KWA, KWB, KWC (10, 20, 30, 40 mm), KWD (10, 20, 30, 40, 60, 80, 100 mm)	215 ZŁ
	ZESTAW TEDEE	1 650 ZŁ
SAMOZAMYKACZ UKRYTY (THERMO PREMIUM)		1100 ZŁ
ELEKTROZACZEP Z FUNKCJĄ DZIEŃ / NOC		250 ZŁ

* DOŚWIETLA ALUMINIOWE STAŁE: STRONY 88-89, PEŁNA LISTA WYPOSAŻENIA: STRONY 94-99

SZYBA



MATOWA



MIRA STAR (SZYBA LUSTRZANA)



KWCB PASAWA 3 B



KWD PASAWA 4



STRONA WEWNĘTRZNA

KONFIGURACJA DRZWI THERMO PRIME 75



KWA PASAWA 1



STRONA WEWNĘTRZNA

OKUCIA KLAMKA-KLAMKA



THERMO PRIME



THERMO PREMIUM

KLAMKA-GAŁKA



THERMO PRIME



THERMO PREMIUM

POCHWYT

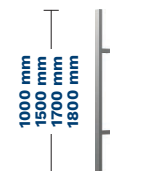

- AMSTERDAM
- MONTREAL

KOLORY OKUĆ

ANODA PLATYNA



ANODA SREBRNA



ANODA CZARNA



KOLORY DRZWI

ORZECH ALPEJSKI



MAHOŃ



ORZECH BRAZYLJSKI



JASNY ORZECH



ZŁOTY DĄB



WINCHESTER



DĄB TURNER



JASNY WENGE



BIAŁY



STALOWOSZARY



ANTRACYT



CIEMNY ANTRACYT



CZARNY





KW3 JENA 3



KW4 JENA 4

ROZMIAR	80	90N	90E	100E
---------	----	-----	-----	------

MODEL	THERMO PREMIUM 60	THERMO PREMIUM 75	THERMO PRIME 75
KW3 / KW3B JENA 3	4 787 Zł	5 219 Zł	6 687 Zł
KW4 / KW4B JENA 4	4 787 Zł	5 219 Zł	6 687 Zł

WYPOSAŻENIE STANDARDOWE RC2

- SKRZYDŁO PRZESZKŁONE SPEŁNIAJĄCE WARUNKI PROGRAMU CZYSTE POWIETRZE
- 4 PRZYLGI SKRZYDŁA
- THERMO PREMIUM OŚCIEŻNICA DUOTHERM / THERMO PRIME OŚCIEŻNICA ALUTHERM PRIME
- ZAWIASY REGULOWANE 3D Z OSŁONKAMI W KOLORZE OKUC
- CIEPLY PRÓG
- KOMPLET OKUC Z OCHRONĄ WKŁADKI
- SZYLDY BERGEN Z KLAMKAMI ALEX
- WKŁADKI W KLASIE 5, SYSTEM JEDNEGO KLUCZA DLA DRZWI THERMO PREMIUM

DOPLATY

WYSOKOŚĆ NIESTANDARDOWA (THERMO PRIME)	2150 - 2200 mm	330 ZŁ
DOSTĘPNE KOLORY: FRP, FDE, FDW, FKG, FKF	2250 - 2300 mm	680 ZŁ
	2350 - 2400 mm	1100 ZŁ
OŚCIEŻNICA ALUTHERM PREMIUM (DRZWI THERMO PREMIUM)	950 ZŁ	ELEKTROZACZEP Z FUNKCJĄ DZIEŃ / NOC
DRZWI DWUKOLOROWE	500 ZŁ	1800 mm
WKŁADKI W KLASIE 6 W SYSTEMIE JEDNEGO KLUCZA	180 ZŁ	1700 mm
		1500 mm
		1000 mm
OCHRONA GÓRNEGO SZYLDU (THERMO PREMIUM)	30 ZŁ	1800 mm
KLAMKO - GAŁKA	50 ZŁ	1700 mm
KONTAKTRON	120 ZŁ	1500 mm
ROZMIAR 100E	350 ZŁ	1000 mm
SAMOZAMYKACZ UKRYTY (THERMO PREMIUM)	1100 ZŁ	1800 mm
		1700 mm
		1500 mm
		1000 mm
		1800 mm
		1700 mm
		1500 mm
		1000 mm
		1640 ZŁ
		1620 ZŁ
		1590 ZŁ
		1540 ZŁ
		215 ZŁ
		1650 ZŁ

* DOŚWIETLA ALUMINIOWE STAŁE: STRONY 88-89, PEŁNA LISTA WYPOSAŻENIA: STRONY 94-99

SZYBA



MATOWA



MIRA STAR (SZYBA LUSTRZANA)

KOLORY DRZWI

ORZECH ALPEJSKI



FRR

MAHOŃ



FMA

ORZECH BRAZYLIJSKI



FRB

JASNY ORZECH



FRP

ZŁOTY DĄB



FDE

WINCHESTER



FDW

DĄB TURNER



FDT

JASNY WENGE



FEJ

BIAŁY



FSB

STALOWOSZARY



FKZ

ANTRACYT



FKG

CIEMNY ANTRACYT



FKF

CZARNY



FKC



KW3B JENA 3 B

KONFIGURACJA DRZWI THERMO PRIME 75



STRONA WEWNĘTRZNA

STRONA WEWNĘTRZNA

OKUCIA

KLAMKA-KLAMKA



THERMO PRIME



THERMO PREMIUM

KLAMKA-GAŁKA



THERMO PRIME



THERMO PREMIUM

POCHWYT



□ AMSTERDAM
○ MONTREAL

KOLORY OKUĆ

ANODA PLATYNA



ANODA SREBRNA



ANODA CZARNA



KOLORY DRZWI

ORZECH ALPEJSKI



MAHOŃ



ORZECH BRAZYLIJSKI



JASNY ORZECH



ZŁOTY DĄB



WINCHESTER



DĄB TURNER



JASNY WENGE



BIAŁY



STALOWOSZARY



ANTRACYT



CIEMNY ANTRACYT



CZARNY





KWF BAMBERG 1



KWG BAMBERG 2

KOLORY DRZWI

ORZECH ALPEJSKI



FRR

MAHOŃ



FMA

ORZECH BRAZYLIJSKI



FRB

JASNY ORZECH



FRP

ZŁOTY DĄB



FDE

WINCHESTER



FDW

DĄB TURNER



FDT

JASNY WENGE



FEJ

BIAŁY



FSB

STALOWOSZARY



FKZ

ANTRACYT



FKG

CIEMNY ANTRACYT



FKF

CZARNY



FKC

ROZMIAR

	80	90N	90E	100E
--	----	-----	-----	------

MODEL

	THERMO PREMIUM 60	THERMO PREMIUM 75	THERMO PRIME 75
KWF / KWFB BAMBERG 1	4 952 Zł	5 384 Zł	6 852 Zł
KWG / KWGB BAMBERG 2	4 787 Zł	5 219 Zł	6 687 Zł
KWH / KWHB BAMBERG 3	4 952 Zł	5 384 Zł	6 852 Zł
KWI / KWIB BAMBERG 4	4 787 Zł	5 219 Zł	6 687 Zł

WYPOSAŻENIE STANDARDOWE RC2

- SKRZYDŁO PRZESZKLONE SPEŁNIAJĄCE WARUNKI PROGRAMU CZYSTE POWIETRZE
- 4 PRZYLGI SKRZYDŁA
- THERMO PREMIUM OŚCIEŻNICA DUOTHERM / THERMO PRIME OŚCIEŻNICA ALUTHERM PRIME
- ZAWIASY REGULOWANE 3D Z OSŁONKAMI W KOLORZE OKUĆ
- CIEPLY PRÓG
- KOMPLET OKUĆ Z OCHRONĄ WKŁADKI
- SZYLDY BERGEN Z KLAMKAMI ALEX
- WKŁADKI W KLASIE 5, SYSTEM JEDNEGO KLUCZA DLA DRZWI THERMO PREMIUM

• INSERTY

INOX

BLACK

DOPLĄTY

WYSOKOŚĆ NIESTANDARDOWA (THERMO PRIME)	2150 - 2200 mm	330 Zł
DOSTĘPNE KOLORY: FRP, FDE, FDW, FKG, FKF	2250 - 2300 mm	680 Zł
	2350 - 2400 mm	1100 Zł
OŚCIEŻNICA ALUTHERM PREMIUM (DRZWI THERMO PREMIUM)	950 Zł	ELEKTROZACZEP Z FUNKCJĄ DZIEŃ / NOC
DRZWI DWUKOLOROWE	500 Zł	1800 mm
WKŁADKI W KLASIE 6 W SYSTEMIE JEDNEGO KLUCZA	180 Zł	1700 mm
		1500 mm
		1000 mm
OCHRONA GÓRNEGO SZYLDU (THERMO PREMIUM)	30 Zł	1800 mm
KLAMKO - GAŁKA	50 Zł	1700 mm
KONTAKTRON	120 Zł	1500 mm
ROZMIAR 100E	350 Zł	1000 mm
SAMOZAMYKACZ UKRYTY (THERMO PREMIUM)	1100 Zł	1800 mm
		1700 mm
		1500 mm
		1000 mm
		SKRACANIE DRZWI (10, 20, 30, 40 mm)
		215 Zł
		ZESTAW TEDEE
		1 650 Zł

* DOŚWIETLA ALUMINIOWE STAŁE: STRONY 88-89, PEŁNA LISTA WYPOSAŻENIA: STRONY 94-99

SZYBA



MATOWA



MIRA STAR (SZYBA LUSTRZANA)



KWHB BAMBERG 3 B



KWI BAMBERG 4



STRONA WEWNĘTRZNA

KONFIGURACJA DRZWI THERMO PRIME 75



KWF BAMBERG 1

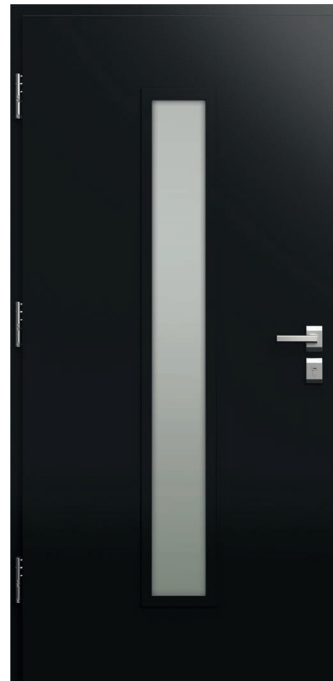

STRONA WEWNĘTRZNA

OKUCIA KLAMKA-KLAMKA



THERMO PRIME



THERMO PREMIUM

KLAMKA-GAŁKA



THERMO PRIME



THERMO PREMIUM

POCHWYT

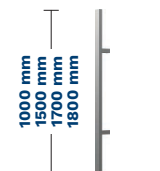

- AMSTERDAM
- MONTREAL

KOLORY OKUĆ

ANODA PLATYNA



ANODA SREBRNA



ANODA CZARNA



KOLORY DRZWI

ORZECH ALPEJSKI



MAHOŃ



ORZECH BRAZYLJSKI



JASNY ORZECH



ZŁOTY DĄB



WINCHESTER



DĄB TURNER



JASNY WENGE



BIAŁY



STALOWOSZARY



ANTRACYT



CIEMNY ANTRACYT

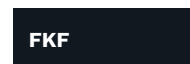

CZARNY





KWJB ULM 1 B



KWK ULM 2

KOLORY DRZWI

ORZECH ALPEJSKI



FRR

MAHOŃ



FMA

ORZECH BRAZYLIJSKI



FRB

JASNY ORZECH



FRP

ZŁOTY DĄB



FDE

WINCHESTER



FDW

DĄB TURNER



FDT

JASNY WENGE



FEJ

BIAŁY

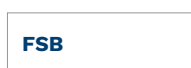

FSB

STALOWOSZARY



FKZ

ANTRACYT



FKG

CIEMNY ANTRACYT



FKF

CZARNY



FKC

ROZMIAR

	80	90N	90E	100E
--	----	-----	-----	------

MODEL

	THERMO PREMIUM 60	THERMO PREMIUM 75	THERMO PRIME 75
KWJ / KWJB ULM 1	4 787 Zł	5 219 Zł	-
KWK / KWKB ULM 2	4 787 Zł	5 219 Zł	6 687 Zł

WYPOSAŻENIE STANDARDOWE RC2

- SKRZYDŁO PRZESZKLONE SPEŁNIAJĄCE WARUNKI PROGRAMU CZYSTE POWIETRZE
- 4 PRZYLGI SKRZYDŁA
- THERMO PREMIUM OŚCIEŻNICA DUOTHERM / THERMO PRIME OŚCIEŻNICA ALUTHERM PRIME
- ZAWIASY REGULOWANE 3D Z OSŁONKAMI W KOLORZE OKUC
- CIEPLY PRÓG
- KOMPLET OKUĆ Z OCHRONĄ WKŁADKI
- SZYLDY BERGEN Z KLAMKAMI ALEX
- WKŁADKI W KLASIE 5, SYSTEM JEDNEGO KLUCZA DLA DRZWI THERMO PREMIUM

• INSERTY **INOX** **BLACK**

DOPLĄTY

WYSOKOŚĆ NIESTANDARDOWA (THERMO PRIME)	2150 - 2200 mm	330 ZŁ
DOSTĘPNE KOLORY: FRP, FDE, FDW, FKG, FKF	2250 - 2300 mm	680 ZŁ
	2350 - 2400 mm	1100 ZŁ
OŚCIEŻNICA ALUTHERM PREMIUM (DRZWI THERMO PREMIUM)	950 ZŁ	
DRZWI DWUKOLOROWE	500 ZŁ	
WKŁADKI W KLASIE 6 W SYSTEMIE JEDNEGO KLUCZA	180 ZŁ	
OCHRONA GÓRNEGO SZYLDU (THERMO PREMIUM)	30 ZŁ	
KLAMKO - GAŁKA	50 ZŁ	
KONTAKTRON	120 ZŁ	
ROZMIAR 100E	350 ZŁ	
SAMOZAMYKACZ UKRYTY (THERMO PREMIUM)	1100 ZŁ	
	ELEKTROZACZEP Z FUNKCJĄ DZIĘŃ / NOC	250 ZŁ
	1800 mm	825 ZŁ
	1700 mm	800 ZŁ
	1500 mm	770 ZŁ
	1000 mm	715 ZŁ
	1800 mm	1 640 ZŁ
	1700 mm	1 620 ZŁ
	1500 mm	1 590 ZŁ
	1000 mm	1 540 ZŁ
	SKRACANIE DRZWI (10, 20, 30, 40, 60, 80, 100 mm)	215 ZŁ
	ZESTAW TEDEE	1 650 ZŁ

* DOŚWIETLA ALUMINIOWE STAŁE: STRONY 88-89, PEŁNA LISTA WYPOSAŻENIA: STRONY 94-99

SZYBA



MATOWA



MIRA STAR (SZYBA LUSTRZANA)





KWJ ULM 2

KONFIGURACJA DRZWI THERMO PRIME 75



STRONA WEWNĘTRZNA

STRONA WEWNĘTRZNA

OKUCIA

KLAMKA-KLAMKA



THERMO PRIME



THERMO PREMIUM

KLAMKA-GAŁKA



THERMO PRIME



THERMO PREMIUM

POCHWYT



AMSTERDAM
 MONTREAL

KOLORY OKUĆ

ANODA PLATYNA



ANODA SREBRNA



ANODA CZARNA



KOLORY DRZWI

ORZECH ALPEJSKI



MAHOŃ



ORZECH BRAZYLIJSKI



JASNY ORZECH



ZŁOTY DĄB



WINCHESTER



DĄB TURNER



JASNY WENGE



BIAŁY



STALOWOSZARY



ANTRACYT



CIEMNY ANTRACYT



CZARNY





KWL TREWIR 1



KWMB TREWIR 2 B

ROZMIAR	80	90N	90E	100E
---------	----	-----	-----	------

MODEL	THERMO PREMIUM 60	THERMO PREMIUM 75	THERMO PRIME 75
KWL / KWL B TREWIR 1	4 952 Zł	5 384 Zł	6 852 Zł
KWM / KWMB TREWIR 2	4 787 Zł	5 219 Zł	6 687 Zł
KWN / KWNB TREWIR 3	4 952 Zł	5 384 Zł	6 852 Zł
KWP / KWPB TREWIR 4	4 787 Zł	5 219 Zł	6 687 Zł
KW7 / KW7B TREWIR 7	4 787 Zł	5 219 Zł	6 687 Zł

WYPOSAŻENIE STANDARDOWE RC2

- SKRZYDŁO PRZESZKLONE SPEŁNIAJĄCE WARUNKI PROGRAMU CZYSTE POWIETRZE
 - 4 PRZYLGI SKRZYDŁA
 - THERMO PREMIUM OŚCIEŻNICA DUOTHERM / THERMO PRIME OŚCIEŻNICA ALUTHERM PRIME
 - ZAWIASY REGULOWANE 3D Z OSŁONKAMI W KOLORZE OKUĆ
 - CIEPŁY PRÓG
 - KOMPLET OKUĆ Z OCHRONĄ WKŁADKI
 - SZYLDY BERGEN Z KLAMKAMI ALEX
 - WKŁADKI W KLASIE 5, SYSTEM JEDNEGO KLUCZA DLA DRZWI THERMO PREMIUM
- INSERTY **INOX** **BLACK**

DOPLATY

WYSOKOŚĆ NIESTANDARDOWA (THERMO PRIME)	2150 - 2200 mm	330 ZŁ
DOSTĘPNE KOLORY: FRP, FDE, FDW, FKG, FKF	2250 - 2300 mm	680 ZŁ
	2350 - 2400 mm	1100 ZŁ
OŚCIEŻNICA ALUTHERM PREMIUM (DRZWI THERMO PREMIUM)	ELEKTROZACZEP Z FUNKCJĄ DZIEŃ / NOC	250 ZŁ
DRZWI DWUKOLOROWE	1800 mm	825 ZŁ
WKŁADKI W KLASIE 6 W SYSTEMIE JEDNEGO KLUCZA	POCHWYT AMSTERDAM / MONTREAL ZALECANY ELEKTROZACZEP	1700 mm 800 ZŁ
	1500 mm	770 ZŁ
	1000 mm	715 ZŁ
OCHRONA GÓRNEGO SZYLDU (THERMO PREMIUM)	1800 mm	1 640 ZŁ
KLAMKO - GAŁKA	1700 mm	1 620 ZŁ
KONTAKTRON	1500 mm	1 590 ZŁ
ROZMIAR 100E	1000 mm	1 540 ZŁ
SAMOZAMYKACZ UKRYTY (THERMO PREMIUM)	SKRACANIE DRZWI (10, 20, 30, 40 mm)	215 ZŁ
	ZESTAW TEDEE	1 650 ZŁ

* DOŚWIELTA ALUMINIOWE STAŁE: STRONY 88-89, PEŁNA LISTA WYPOSAŻENIA: STRONY 94-99

SZYBA



MATOWA



GRAFIT



MIRA STAR (SZYBA LUSTRZANA)

KOLORY DRZWI

ORZECH ALPEJSKI



FRR

MAHOŃ



FMA

ORZECH BRAZYLJSKI



FRB

JASNY ORZECH



FRP

ZŁOTY DĄB



FDE

WINCHESTER



FDW

DĄB TURNER



FDT

JASNY WENGE



FEJ

BIAŁY



FSB

STALOWOSZARY



FKZ

ANTRACYT



FKG

CIEMNY ANTRACYT



FKF

CZARNY



FKC



KWN TREWIR 3



KWP TREWIR 4



KW7 TREWIR 7

KONFIGURACJA DRZWI THERMO PRIME 75



KWL TREWIR 1



STRONA WEWNĘTRZNA

OKUCIA KLAMKA-KLAMKA



THERMO PRIME



THERMO PREMIUM

KLAMKA-GAŁKA



THERMO PRIME



THERMO PREMIUM

POCHWYT

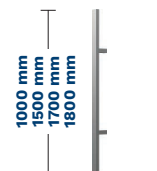

- AMSTERDAM
- MONTREAL

KOLORY OKUĆ

ANODA PLATYNA



ANODA SREBRNA



ANODA CZARNA



KOLORY DRZWI

ORZECH ALPEJSKI



MAHOŃ



ORZECH BRAZYLJSKI



JASNY ORZECH



ZŁOTY DĄB



WINCHESTER



DĄB TURNER



JASNY WENGE



BIAŁY



STALOWOSZARY



ANTRACYT



CIEMNY ANTRACYT



CZARNY





KWSB DORFEN B

ROZMIAR	80	90N	90E	100E
----------------	----	-----	-----	------

MODEL	THERMO PREMIUM 60	THERMO PREMIUM 75	THERMO PRIME 75
KWS / KWSB DORFEN	5 117 ZŁ	5 219 ZŁ	6 687 ZŁ

WYPOSAŻENIE STANDARDOWE RC2

- SKRZYDŁO PRZESZKLONE SPEŁNIAJĄCE WARUNKI PROGRAMU CZYSTE POWIETRZE
- 4 PRZYLGI SKRZYDŁA
- THERMO PREMIUM OŚCIEŻNICA DUOTHERM / THERMO PRIME OŚCIEŻNICA ALUTHERM PRIME
- ZAWIASY REGULOWANE 3D Z OSŁONKAMI W KOLORZE OKUĆ
- CIEPŁY PRÓG
- KOMPLET OKUĆ Z OCHRONĄ WKŁADKI
- SZYLDY BERGEN Z KLAMKAMI ALEX
- WKŁADKI W KLASIE 5, SYSTEM JEDNEGO KLUCZA DLA DRZWI THERMO PREMIUM

• INSERTY **INOX** **BLACK**

DOPLĄTY

WYSOKOŚĆ NIESTANDARDOWA (THERMO PRIME)	2150 – 2200 mm	330 ZŁ
DOSTĘPNE KOLORY: FRP, FDE, FDW, FKG, FKF	2250 – 2300 mm	680 ZŁ
	2350 – 2400 mm	1100 ZŁ
OŚCIEŻNICA ALUTHERM PREMIUM (DRZWI THERMO PREMIUM)	950 ZŁ	ELEKTROZACZEP Z FUNKCJĄ DZIEŃ / NOC
		1800 mm 825 ZŁ
DRZWI DWUKOLOROWE	500 ZŁ	POCHWYT AMSTERDAM / MONTREAL ZALECANY ELEKTROZACZEP
		1700 mm 800 ZŁ
WKŁADKI W KLASIE 6 W SYSTEMIE JEDNEGO KLUCZA	180 ZŁ	1500 mm 770 ZŁ
		1000 mm 715 ZŁ
OCHRONA GÓRNEGO SZYLDU (THERMO PREMIUM)	30 ZŁ	1800 mm 1 640 ZŁ
		1700 mm 1 620 ZŁ
KLAMKO - GAŁKA	50 ZŁ	1500 mm 1 590 ZŁ
		1000 mm 1 540 ZŁ
KONTAKTRON	120 ZŁ	SKRACANIE DRZWI (10, 20, 30, 40 mm)
ROZMIAR 100E	350 ZŁ	215 ZŁ
SAMOZAMYKACZ UKRYTY (THERMO PREMIUM)	1100 ZŁ	ZESTAW TEDEE
		1 650 ZŁ

* DOŚWIETLA ALUMINIOWE STAŁE: STRONY 88-89, PEŁNA LISTA WYPOSAŻENIA: STRONY 94-99

SZYBA



MATOWA



GRAFIT



MIRA STAR (SZYBA LUSTRZANA)

KOLORY DRZWI

ORZECH ALPEJSKI



FRR

MAHOŃ



FMA

ORZECH BRAZYLIJSKI



FRB

JASNY ORZECH



FRP

ZŁOTY DĄB



FDE

WINCHESTER



FDW

DĄB TURNER



FDT

JASNY WENGE



FEJ

BIAŁY



FSB

STALOWOSZARY



FKZ

ANTRACYT



FKG

CIEMNY ANTRACYT



FKF

CZARNY



FKC



KWS DORFEN

KONFIGURACJA DRZWI THERMO PRIME 75



STRONA WEWNĘTRZNA

STRONA WEWNĘTRZNA

OKUCIA

KLAMKA-KLAMKA



THERMO PRIME



THERMO PREMIUM

KLAMKA-GAŁKA



THERMO PRIME



THERMO PREMIUM

POCHWYT

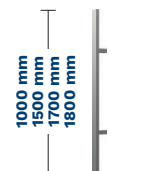

□ **AMSTERDAM**
○ **MONTREAL**

KOLORY OKUĆ

ANODA PLATYNA



ANODA SREBRNA



ANODA CZARNA



KOLORY DRZWI

ORZECH ALPEJSKI



MAHOŃ



ORZECH BRAZYLJSKI



JASNY ORZECH



ZŁOTY DĄB



WINCHESTER



DĄB TURNER



JASNY WENGE



BIAŁY



STALOWOSZARY



ANTRACYT



CIEMNY ANTRACYT



CZARNY





KWT KASSEL 1



KWXB KASSEL 2 B

ROZMIAR	80	90N	90E	100E
---------	----	-----	-----	------

MODEL	THERMO PREMIUM 60	THERMO PREMIUM 75	THERMO PRIME 75
KWT / KWTB KASSEL 1	5 117 Zł	5 549 Zł	7 017 Zł
KWX / KWXB KASSEL 2	4 952 Zł	5 384 Zł	6 852 Zł

WYPOSAŻENIE STANDARDOWE RC2

- SKRZYDŁO PRZESZKŁONE SPEŁNIAJĄCE WARUNKI PROGRAMU CZYSTE POWIETRZE
- 4 PRZYLGI SKRZYDŁA
- THERMO PREMIUM OŚCIEŻNICA DUOTHERM / THERMO PRIME OŚCIEŻNICA ALUTHERM PRIME
- ZAWIASY REGULOWANE 3D Z OSŁONKAMI W KOLORZE OKUC
- CIEPLY PRÓG
- KOMPLET OKUC Z OCHRONĄ WKŁADKI
- SZYLDY BERGEN Z KLAMKAMI ALEX
- WKŁADKI W KLASIE 5, SYSTEM JEDNEGO KLUCZA DLA DRZWI THERMO PREMIUM

• INSERTY **INOX** **BLACK**

DOPLĄTY

WYSOKOŚĆ NIESTANDARDOWA (THERMO PRIME)	2150 - 2200 mm	330 Zł
DOSTĘPNE KOLORY: FRP, FDE, FDW, FKG, FKF	2250 - 2300 mm	680 Zł
	2350 - 2400 mm	1100 Zł
	ELEKTROZACZEP Z FUNKCJĄ DZIEN / NOC	250 Zł
OŚCIEŻNICA ALUTHERM PREMIUM (DRZWI THERMO PREMIUM)	950 Zł	1800 mm 825 Zł
DRZWI DWUKOLOROWE	500 Zł	1700 mm 800 Zł
WKŁADKI W KLASIE 6 W SYSTEMIE JEDNEGO KLUCZA	180 Zł	1500 mm 770 Zł
		1000 mm 715 Zł
OCHRONA GÓRNEGO SZYLDU (THERMO PREMIUM)	30 Zł	1800 mm 1 640 Zł
		1700 mm 1 620 Zł
KLAMKO - GAŁKA	50 Zł	1500 mm 1 590 Zł
KONTAKTRON	120 Zł	1000 mm 1 540 Zł
ROZMIAR 100E	350 Zł	SKRACANIE DRZWI (10, 20, 30, 40 mm)
SAMOZAMYKACZ UKRYTY (THERMO PREMIUM)	1100 Zł	215 Zł
		ZESTAW TEDEE 1 650 Zł

* DOŚWIETLA ALUMINIOWE STAŁE: STRONY 88-89, PEŁNA LISTA WYPOSAŻENIA: STRONY 94-99

SZYBA



MATOWA



GRAFIT



MIRA STAR (SZYBA LUSTRZANA)

KOLORY DRZWI

ORZECH ALPEJSKI	MAHOŃ	ORZECH BRAZYLIJSKI	JASNY ORZECH	ZŁOTY DĄB	WINCHESTER	DĄB TURNER
FRR	FMA	FRB	FRP	FDE	FDW	FDT
JASNY WENGE	BIAŁY	STALOWOSZARY	ANTRACYT	CIEMNY ANTRACYT	CZARNY	
FEJ	FSB	FKZ	FKG	FKF	FKC	



KWT KASSEL 1

KONFIGURACJA DRZWI THERMO PRIME 75



STRONA WEWNĘTRZNA

STRONA WEWNĘTRZNA

OKUCIA

KLAMKA-KLAMKA



THERMO PRIME



THERMO PREMIUM

KLAMKA-GAŁKA



THERMO PRIME

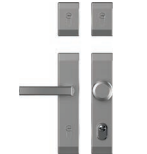

THERMO PREMIUM

POCHWYT



AMSTERDAM
 MONTREAL

KOLORY OKUĆ

ANODA PLATYNA



ANODA SREBRNA



ANODA CZARNA



KOLORY DRZWI

ORZECH ALPEJSKI



MAHOŃ



ORZECH BRAZYLJSKI



JASNY ORZECH



ZŁOTY DĄB



WINCHESTER



DĄB TURNER



JASNY WENGE



BIAŁY



STALOWOSZARY



ANTRACYT



CIEMNY ANTRACYT



CZARNY



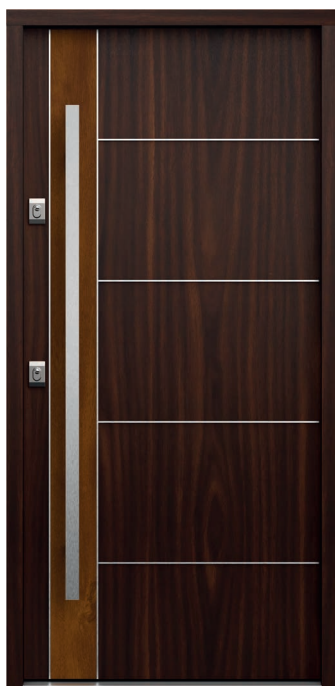

KPN KRONACH 1



KPPB KRONACH 2 B

KOLORY DRZWI

ORZECH ALPEJSKI



FRR

MAHOŃ



FMA

ORZECH BRAZYLIJSKI



FRB

JASNY ORZECH



FRP

ZŁOTY DĄB



FDE

WINCHESTER



FDW

DĄB TURNER



FDT

JASNY WENGE



FEJ

BIAŁY



FSB

STALOWOSZARY



FKZ

ANTRACYT



FKG

CIEMNY ANTRACYT



FKF

CZARNY



FKC

ROZMIAR

80	90N	90E	100E
----	-----	-----	------

MODEL

	THERMO PREMIUM 60	THERMO PREMIUM 75	THERMO PRIME 75
KPN / KPNB KRONACH 1	4 182 Zł	4 614 Zł	6 082 Zł
KPP / KPPB KRONACH 2	4 045 Zł	4 477 Zł	5 945 Zł
KPT / KPTB KRONACH 3	4 182 Zł	4 614 Zł	-
KPZ / KPZB KRONACH 4	4 045 Zł	4 477 Zł	-

WYPOSAŻENIE STANDARDOWE RC2

- SKRZYDŁO PRZESZKLONE SPEŁNIAJĄCE WARUNKI PROGRAMU CZYSTE POWIETRZE
- 4 PRZYLGI SKRZYDŁA
- THERMO PREMIUM OŚCIEŻNICA DUOTHERM / THERMO PRIME OŚCIEŻNICA ALUTHERM PRIME
- ZAWIASY REGULOWANE 3D Z OSŁONKAMI W KOLORZE OKUĆ
- CIEPLY PRÓG
- KOMPLET OKUĆ Z OCHRONĄ WKŁADKI
- SZYLDY BERGEN Z KLAMKAMI ALEX
- WKŁADKI W KLASIE 5, SYSTEM JEDNEGO KLUCZA DLA DRZWI THERMO PREMIUM

• INSERTY

INOX

BLACK

DOPLĄTY

WYSOKOŚĆ NIESTANDARDOWA (THERMO PRIME)	2150 - 2200 mm	330 Zł
DOSTĘPNE KOLORY: FRP, FDE, FDW, FKG, FKF	2250 - 2300 mm	680 Zł
	2350 - 2400 mm	1100 Zł
OŚCIEŻNICA ALUTHERM PREMIUM (DRZWI THERMO PREMIUM)	ROZMIAR 100E	350 Zł
DRZWI DWUKOLOROWE	ELEKTROZACZEP Z FUNKCJĄ DZIEŃ / NOC	250 Zł
PAKIET RC3		
WKŁADKI W KLASIE 6 W SYSTEMIE JEDNEGO KLUCZA	1800 mm	825 Zł
OCHRONA GÓRNEGO SZYLDU (THERMO PREMIUM)	1700 mm	800 Zł
KLAMKO - GAŁKA	1500 mm	770 Zł
KONTAKTRON	1000 mm	715 Zł
INSERT I APLIKACJA DRUGA STRONA	1800 mm	1 640 Zł
INSERT DRUGA STRONA	1700 mm	1 620 Zł
SAMOZAMYKACZ UKRYTY (THERMO PREMIUM)	1500 mm	1 590 Zł
	1000 mm	1 540 Zł
	SKRACANIE DRZWI (10, 20, 30, 40 mm)	215 Zł
	ZESTAW TEDEE	1 650 Zł

* DOŚWIETLA ALUMINIOWE STAŁE: STRONY 88-89, PEŁNA LISTA WYPOSAŻENIA: STRONY 94-99



KPT KRONACH 3



KPZ KRONACH 4



STRONA WEWNĘTRZNA

KONFIGURACJA DRZWI THERMO PRIME 75



KPN KRONACH 1



STRONA WEWNĘTRZNA

OKUCIA KLAMKA-KLAMKA



THERMO PRIME



THERMO PREMIUM

KLAMKA-GAŁKA



THERMO PRIME



THERMO PREMIUM

POCHWYT

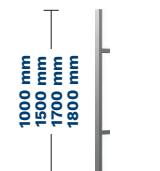

- AMSTERDAM**
- MONTREAL**

KOLORY OKUĆ

ANODA PLATYNA



ANODA SREBRNA



ANODA CZARNA



KOLORY DRZWI

ORZECH ALPEJSKI



MAHOŃ



ORZECH BRAZYLIIJSKI



JASNY ORZECH



ZŁOTY DĄB



WINCHESTER



DĄB TURNER



JASNY WENGE



BIAŁY



STALOWOSZARY



ANTRACYT



CIEMNY ANTRACYT



CZARNY





KPJ REGEN 1



KPK REGEN 2

KOLORY DRZWI

ORZECH ALPEJSKI



FRR

MAHOŃ



FMA

ORZECH BRAZYLIJSKI



FRB

JASNY ORZECH



FRP

ZŁOTY DĄB



FDE

WINCHESTER



FDW

DĄB TURNER



FDT

JASNY WENGE



FEJ

BIAŁY



FSB

STALOWOSZARY



FKZ

ANTRACYT



FKG

CIEMNY ANTRACYT



FKF

CZARNY



FKC

ROZMIAR

	80	90N	90E	100E
--	----	-----	-----	------

MODEL

	THERMO PREMIUM 60	THERMO PREMIUM 75	THERMO PRIME 75
KPJ / KPJB REGEN 1	4 082 Zł	4 514 Zł	5 982 Zł
KPK / KPKB REGEN 2	3 907 Zł	4 339 Zł	5 807 Zł
KPL / KPLB REGEN 3	4 082 Zł	4 514 Zł	5 982 Zł
KPS / KPSB REGEN 4	3 907 Zł	4 339 Zł	5 807 Zł
KPM / KPMB REGEN 5	4 082 Zł	4 514 Zł	5 982 Zł
KPR / KPRB REGEN 6	3 907 Zł	4 339 Zł	5 807 Zł

WYPOSAŻENIE STANDARDOWE RC2

- SKRZYDŁO PRZESZKLONE SPEŁNIAJĄCE WARUNKI PROGRAMU CZYSTE POWIETRZE
- 4 PRZYLGI SKRZYDŁA
- THERMO PREMIUM OŚCIEŻNICA DUOTHERM / THERMO PRIME OŚCIEŻNICA ALUTHERM PRIME
- ZAWIASY REGULOWANE 3D Z OSŁONKAMI W KOLORZE OKUĆ
- CIEPŁY PRÓG
- KOMPLET OKUĆ Z OCHRONĄ WKŁADKI
- SZYLDY BERGEN Z KLAMKAMI ALEX
- WKŁADKI W KLASIE 5, SYSTEM JEDNEGO KLUCZA DLA DRZWI THERMO PREMIUM

• INSERTY

INOX

BLACK

DOPLĄTY

WYSOKOŚĆ NIESTANDARDOWA (THERMO PRIME)		2150 - 2200 mm	330 ZŁ
DOSTĘPNE KOLORY: FRP, FDE, FDW, FKG, FKF		2250 - 2300 mm	680 ZŁ
		2350 - 2400 mm	1100 ZŁ
OŚCIEŻNICA ALUTHERM PREMIUM (DRZWI THERMO PREMIUM)	950 ZŁ	ROZMIAR 100E	350 ZŁ
DRZWI DWUKOLOROWE	500 ZŁ	ELEKTROZACZEP Z FUNKCJĄ DZIEŃ / NOC	250 ZŁ
PAKIET RC3	370 ZŁ		1800 mm 825 ZŁ
WKŁADKI W KLASIE 6 W SYSTEMIE JEDNEGO KLUCZA	180 ZŁ	POCHWYT AMSTERDAM / MONTREAL ZALECANY ELEKTROZACZEP	1700 mm 800 ZŁ
OCHRONA GÓRNEGO SZYLDU (THERMO PREMIUM)	30 ZŁ		1500 mm 770 ZŁ
KLAMKO - GAŁKA	50 ZŁ		1000 mm 715 ZŁ
KONTAKTRON	120 ZŁ	POCHWYT Z PRZYCISKIEM AMSTERDAM / MONTREAL Z DOSTOSOWANIEM SKRZYDŁA ORAZ ELEKTROZACZEP	1800 mm 1 640 ZŁ
INSERT I APLIKACJA DRUGA STRONA	500 ZŁ		1700 mm 1 620 ZŁ
INSERT DRUGA STRONA	300 ZŁ		1500 mm 1 590 ZŁ
SAMOZAMYKACZ UKRYTY (THERMO PREMIUM)	1100 ZŁ		1000 mm 1 540 ZŁ
		SKRACANIE DRZWI (10, 20, 30, 40 mm)	215 ZŁ
		ZESTAW TEDEE	1 650 ZŁ

* DOŚWIETLA ALUMINIOWE STAŁE: STRONY 88-89, PEŁNA LISTA WYPOSAŻENIA: STRONY 94-99



KPL REGEN 3



KPS REGEN 4



KPM REGEN 5

KONFIGURACJA DRZWI THERMO PRIME 75



KPRB REGEN 6 B



KPJ REGEN 1



STRONA WEWNĘTRZNA

OKUCIA KLAMKA-KLAMKA



THERMO PRIME



THERMO PREMIUM

KLAMKA-GAŁKA



THERMO PRIME



THERMO PREMIUM

POCHWYT

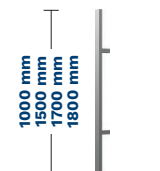

- AMSTERDAM
- MONTREAL

KOLORY OKUĆ

ANODA PLATYNA



ANODA SREBRNA



ANODA CZARNA



KOLORY DRZWI

ORZECH ALPEJSKI



MAHOŃ



ORZECH BRAZYLIJSKI



JASNY ORZECH



ZŁOTY DĄB



WINCHESTER



DĄB TURNER



JASNY WENGE



BIAŁY



STALOWOSZARY



ANTRACYT



CIEMNY ANTRACYT



CZARNY





KPE DREZNO 1



KPFB DREZNO 2 B

ROZMIAR	80	90N	90E	100E
---------	----	-----	-----	------

MODEL	THERMO PREMIUM 60	THERMO PREMIUM 75	THERMO PRIME 75
KPE / KPFB DREZNO 1	3 907 Zł	4 339 Zł	-
KPF / KPFB DREZNO 2	3 907 Zł	4 339 Zł	-
KPH / KPFB DREZNO 4	3 907 Zł	4 339 Zł	5 807 Zł

WYPOSAŻENIE STANDARDOWE RC2

- SKRZYDŁO PRZESZKŁONE SPEŁNIAJĄCE WARUNKI PROGRAMU CZYSTE POWIETRZE
- 4 PRZYLGI SKRZYDŁA
- THERMO PREMIUM OŚCIEŻNICA DUOTHERM / THERMO PRIME OŚCIEŻNICA ALUTHERM PRIME
- ZAWIASY REGULOWANE 3D Z OSŁONKAMI W KOLORZE OKUĆ
- CIEPLY PRÓG
- KOMPLET OKUĆ Z OCHRONĄ WKŁADKI
- SZYLDY BERGEN Z KLAMKAMI ALEX
- WKŁADKI W KLASIE 5, SYSTEM JEDNEGO KLUCZA DLA DRZWI THERMO PREMIUM

INSERTY **INOX** **BLACK**

DOPLATY

WYSOKOŚĆ NIESTANDARDOWA (THERMO PRIME)	2150 - 2200 mm	330 Zł
DOSTĘPNE KOLORY: FRP, FDE, FDW, FKG, FKF	2250 - 2300 mm	680 Zł
	2350 - 2400 mm	1100 Zł
OŚCIEŻNICA ALUTHERM PREMIUM (DRZWI THERMO PREMIUM)	950 Zł	ELEKTROZACZEP Z FUNKCJĄ DZIEŃ / NOC 250 Zł
DRZWI DWUKOLOROWE	500 Zł	1800 mm 825 Zł
PAKIET RC3	370 Zł	1700 mm 800 Zł
WKŁADKI W KLASIE 6 W SYSTEMIE JEDNEGO KLUCZA	180 Zł	1500 mm 770 Zł
		1000 mm 715 Zł
OCHRONA GÓRNEGO SZYLDU (THERMO PREMIUM)	30 Zł	1800 mm 1 640 Zł
KLAMKO - GAŁKA	50 Zł	1700 mm 1 620 Zł
KONTAKTRON	120 Zł	1500 mm 1 590 Zł
INSERT DRUGA STRONA	300 Zł	1000 mm 1 540 Zł
ROZMIAR 100E	350 Zł	SKRACANIE DRZWI KPH (10, 20, 30, 40 mm), KPE, KPF (10, 20, 30, 40, 60, 80, 100 mm) 215 Zł
SAMOZAMYKACZ UKRYTY (THERMO PREMIUM)	1100 Zł	ZESTAW TEDEE 1 650 Zł

* DOŚWIETLA ALUMINIOWE STAŁE: STRONY 88-89, PEŁNA LISTA WYPOSAŻENIA: STRONY 94-99

KOLORY DRZWI

ORZECH ALPEJSKI



FRR

MAHOŃ



FMA

ORZECH BRAZYLIJSKI



FRB

JASNY ORZECH



FRP

ZŁOTY DĄB



FDE

WINCHESTER



FDW

DĄB TURNER



FDT

JASNY WENGE



FEJ

BIAŁY



FSB

STALOWOSZARY



FKZ

ANTRACYT



FKG

CIEMNY ANTRACYT



FKF

CZARNY



FKC



KPH DREZNO 4



STRONA WEWNĘTRZNA

KONFIGURACJA DRZWI THERMO PRIME 75



KPE DREZNO 4

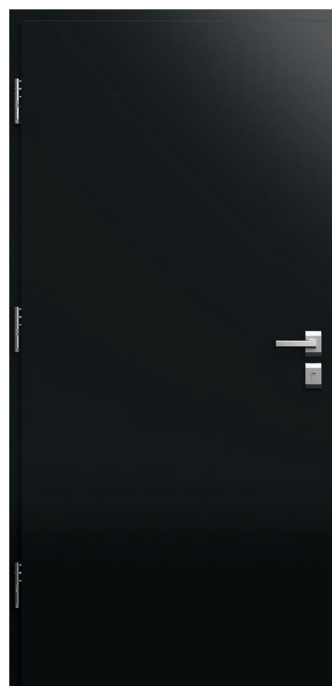

STRONA WEWNĘTRZNA

OKUCIA

KLAMKA-KLAMKA



THERMO PRIME



THERMO PREMIUM

KLAMKA-GAŁKA



THERMO PRIME



THERMO PREMIUM

POCHWYT



□ AMSTERDAM
○ MONTREAL

KOLORY OKUĆ

ANODA PLATYNA



ANODA SREBRNA



ANODA CZARNA



KOLORY DRZWI

ORZECH ALPEJSKI



MAHOŃ



ORZECH BRAZYLIJSKI



JASNY ORZECH



ZŁOTY DĄB



WINCHESTER



DĄB TURNER



JASNY WENGE



BIAŁY



STALOWOSZARY



ANTRACYT



CIEMNY ANTRACYT



CZARNY





KPAB ERFURT 1 B



KPBB ERFURT 2

ROZMIAR	80	90N	90E	100E
---------	----	-----	-----	------

MODEL	THERMO PREMIUM 60	THERMO PREMIUM 75	THERMO PRIME 75
KPA / KPAB ERFURT 1	3 907 Zł	4 339 Zł	5 807 Zł
KPB / KPBB ERFURT 2	3 907 Zł	4 339 Zł	5 807 Zł
KPC / KPCB ERFURT 3	3 907 Zł	4 339 Zł	5 807 Zł

WYPOSAŻENIE STANDARDOWE RC2

- SKRZYDŁO PRZESZKŁONE SPEŁNIAJĄCE WARUNKI PROGRAMU CZYSTE POWIETRZE
- 4 PRZYLGI SKRZYDŁA
- THERMO PREMIUM OŚCIEŻNICA DUOTHERM / THERMO PRIME OŚCIEŻNICA ALUTHERM PRIME
- ZAWIASY REGULOWANE 3D Z OSŁONKAMI W KOLORZE OKUĆ
- CIEPLY PRÓG
- KOMPLET OKUĆ Z OCHRONĄ WKŁADKI
- SZYLDY BERGEN Z KLAMKAMI ALEX
- WKŁADKI W KLASIE 5, SYSTEM JEDNEGO KLUCZA DLA DRZWI THERMO PREMIUM

INSERTY **INOX** **BLACK**

DOPLATY

WYSOKOŚĆ NIESTANDARDOWA (THERMO PRIME)	2150 - 2200 mm	330 Zł
DOSTĘPNE KOLORY: FRP, FDE, FDW, FKG, FKF	2250 - 2300 mm	680 Zł
	2350 - 2400 mm	1100 Zł
OŚCIEŻNICA ALUTHERM PREMIUM (DRZWI THERMO PREMIUM)	950 Zł	ELEKTROZACZEP Z FUNKCJĄ DZIEŃ / NOC 250 Zł
DRZWI DWUKOLOROWE	500 Zł	1800 mm 825 Zł
PAKIET RC3	370 Zł	1700 mm 800 Zł
WKŁADKI W KLASIE 6 W SYSTEMIE JEDNEGO KLUCZA	180 Zł	1500 mm 770 Zł
		1000 mm 715 Zł
OCHRONA GÓRNEGO SZYLDU (THERMO PREMIUM)	30 Zł	1800 mm 1 640 Zł
		1700 mm 1 620 Zł
KLAMKO - GAŁKA	50 Zł	1500 mm 1 590 Zł
KONTAKTRON	120 Zł	1000 mm 1 540 Zł
INSERT DRUGA STRONA	300 Zł	POCHWYT Z PRZYCISKIEM AMSTERDAM / MONTREAL Z DOSTOSOWANIEM SKRZYDŁA ORAZ ELEKTROZACZEPEM
ROZMIAR 100E	350 Zł	1800 mm 1 640 Zł
		1700 mm 1 620 Zł
		1500 mm 1 590 Zł
		1000 mm 1 540 Zł
SAMOZAMYKACZ UKRYTY (THERMO PREMIUM)	1100 Zł	SKRACANIE DRZWI (10, 20, 30, 40 mm) 215 Zł
		ZESTAW TEDEE 1 650 Zł

* DOŚWIETLA ALUMINIOWE STAŁE: STRONY 88-89, PEŁNA LISTA WYPOSAŻENIA: STRONY 94-99

KOLORY DRZWI

ORZECH ALPEJSKI



FRR

MAHOŃ



FMA

ORZECH BRAZYLJSKI

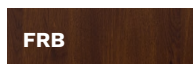

FRB

JASNY ORZECH



FRP

ZŁOTY DĄB



FDE

WINCHESTER



FDW

DĄB TURNER



FDT

JASNY WENGE



FEJ

BIAŁY



FSB

STALOWOSZARY



FKZ

ANTRACYT



FKG

CIEMNY ANTRACYT



FKF

CZARNY



FKC



KPC ERFURT 3



STRONA WEWNĘTRZNA

KONFIGURACJA DRZWI THERMO PRIME 75



KPA ERFURT 1



STRONA WEWNĘTRZNA

OKUCIA KLAMKA-KLAMKA



THERMO PRIME



THERMO PREMIUM

KLAMKA-GAŁKA



THERMO PRIME



THERMO PREMIUM

POCHWYT

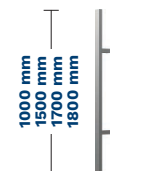

- AMSTERDAM**
- MONTREAL**

KOLORY OKUĆ

ANODA PLATYNA



ANODA SREBRNA



ANODA CZARNA



KOLORY DRZWI

ORZECH ALPEJSKI



MAHOŃ



ORZECH BRAZyliJSKI



JASNY ORZECH



ZŁOTY DĄB



WINCHESTER



DĄB TURNER



JASNY WENGE



BIAŁY



STALOWOSZARY



ANTRACYT



CIEMNY ANTRACYT



CZARNY



ELITE 3D

BRIG / OLTEN / VISP / TRIN / BERNO



ELA BRIG



ELB OLTEN

ROZMIAR	80	90N	90E	100E
---------	----	-----	-----	------

MODEL	THERMO PREMIUM 60	THERMO PREMIUM 75	THERM PRIME 75
ELA BRIG	4 347 Zł	4 779 Zł	6 247 Zł
ELB OLTEN	4 347 Zł	4 779 Zł	6 247 Zł
ELC VISP	3 907 Zł	4 339 Zł	5 807 Zł
ELD TRIN	4 347 Zł	4 779 Zł	6 247 Zł
ELE BERNO	3 097 Zł	4 339 Zł	5 807 Zł

WYPOSAŻENIE STANDARDOWE RC2

- SKRZYDŁO SPEŁNIAJĄCE WARUNKI PROGRAMU CZYSTE POWIETRZE
- 4 PRZYLGI SKRZYDŁA
- THERMO PREMIUM OŚCIEŻNICA DUOTHERM /THERMO PRIME OŚCIEŻNICA ALUTHERM PRIME
- ZAWIASY REGULOWANE 3D Z OSŁONKAMI W KOLORZE OKUC
- CIEPLY PRÓG
- KOMPLET OKUĆ Z OCHRONĄ WKŁADKI
- SZYLDY BERGEN Z KLAMKAMI ALEX
- WKŁADKI W KLASIE 5, SYSTEM JEDNEGO KLUCZA DLA DRZWI THERMO PREMIUM

DOPLATY

WYSOKOŚĆ NIESTANDARDOWA (THERMO PRIME)		2150 - 2200 mm	330 Zł
DOSTĘPNE KOLORY: FRP, FDE, FDW, FKG, FKF		2250 - 2300 mm	680 Zł
		2350 - 2400 mm	1100 Zł
OŚCIEŻNICA ALUTHERM PREMIUM (DRZWI THERMO PREMIUM)	950 Zł	ROZMIAR 100E	350 Zł
DRZWI DWUKOLOROWE	500 Zł	RAMKA DRUGA STRONA	1000 Zł
PAKIET RC3	370 Zł	SAMOZAMYKACZ UKRYTY (THERMO PREMIUM)	1100 Zł
WKŁADKI W KLASIE 6 W SYSTEMIE JEDNEGO KLUCZA	180 Zł	ELEKTROZACZEP Z FUNKCJĄ DZIEŃ / NOC	250 Zł
OCHRONA GÓRNEGO SZYLDU	30 Zł	SKRACANIE DRZWI (10, 20, 30, 40 mm)	215 Zł
KLAMKO - GAŁKA	50 Zł	ZESTAW TEDEE	1 650 Zł
KONTAKTRON	120 Zł		

* DOŚWIETLA ALUMINIOWE STAŁE: STRONY 88-89, PEŁNA LISTA WYPOSAŻENIA: STRONY 94-99

LISTWA



CLASSIC



MODERN



KOLORY DRZWI

ORZECH ALPEJSKI



FRR

MAHOŃ



FMA

ORZECH BRAZYLIJSKI



FRB

JASNY ORZECH



FRP

ZŁOTY DĄB



FDE

WINCHESTER



FDW

DĄB TURNER



FDT

JASNY WENGE



FEJ

BIAŁY



FSB

STALOWOSZARY



FKZ

ANTRACYT



FKG

CIEMNY ANTRACYT



FKF

CZARNY



FKC

GERDA® ELITE 3D BRIG / OLTEN / VISP / TRIN / BERNO



ELC VISP



ELD TRIN



ELE BERNO

KONFIGURACJA DRZWI THERMO PRIME 75



ELA BRIG



STRONA WEWNĘTRZNA

OKUCIA KLAMKA-KLAMKA



THERMO PRIME



THERMO PREMIUM

KLAMKA-GAŁKA



THERMO PRIME



THERMO PREMIUM

KOLORY OKUĆ

ANODA PLATYNA



ANODA SREBRNA



ANODA CZARNA



KOLORY DRZWI

ORZECH ALPEJSKI



FRR

MAHOŃ



FMA

ORZECH BRAZYLIJSKI



FRB

JASNY ORZECH



FRP

ZŁOTY DĄB



FDE

WINCHESTER



FDW

DĄB TURNER



FDT

JASNY WENGE



FEJ

BIAŁY



FSB

STALOWOSZARY



FKZ

ANTRACYT



FKG

CIEMNY ANTRACYT



FKF

CZARNY



FKC



NS1B MILANO 8 B



NS2 MILANO 9

ROZMIAR (THERMO PRIME, THERMO PREMIUM)	-	80	90N	90E	100E
ROZMIAR OPTIMA	80N	80	90N	90E	100E

MODEL	OPTIMA 60	THERMO PREMIUM 60	THERMO PREMIUM 75	THERMO PRIME 75
NS1/NS1B MILANO 8	3 475 Zł	4 017 Zł	4 449 Zł	5 917 Zł
NS2/NS2B MILANO 9	3 475 Zł	4 017 Zł	4 449 Zł	5 917 Zł
NS3/NS3B MILANO 10	3 475 Zł	4 017 Zł	4 449 Zł	5 917 Zł
NS4/NS4B MILANO 11	3 717 Zł	4 182 Zł	4 614 Zł	6 082 Zł
NS9/NS9B MILANO 12	3 475 Zł	4 017 Zł	4 449 Zł	5 917 Zł

WYPOSAŻENIE STANDARDOWE RC2

- SKRZYDŁO PRZESZKLONE SPEŁNIAJĄCE WARUNKI PROGRAMU CZYSTE POWIETRZE
- 4 PRZYLGI SKRZYDŁA THERMO PREMIUM I THERMO PRIME, 3 PRZYLGI SZKRYDŁA OPTIMA
- THERMO PREMIUM OŚCIEŻNICA DUOTHERM / THERMO PRIME OŚCIEŻNICA ALUTHERM PRIME / OPTIMA OŚCIEŻNICA PERFOTHERM
- ZAWIASY REGULOWANE 3D Z OSŁONKAMI W KOLORZE OKUĆ THERMO PREMIUM I THERMO PRIME, ZAWIAS 2D Z OSŁONKAMI W KOLORZE OKUĆ DLA OPTIMA
- WZÓR DWUSTRONNY
- PRÓG ALUMINIOWY
- KOMPLET OKUĆ Z OCHRONĄ WKŁADKI
- SZYLDY DŁUGIE BERGEN THERMO PREMIUM, SZYLDY DZIELONE BERGEN THERMO PRIME, SZYLDY DZIELONE BLOK OPTIMA
- WKŁADKI W KLASIE 5, SYSTEM JEDNEGO KLUCZA DLA DRZWI THERMO PREMIUM I OPTIMA

DOPLĄTY

WYSOKOŚĆ NIESTANDARDOWA (THERMO PRIME)	2150 - 2200 mm	330 ZŁ
DOSTĘPNE KOLORY: FRP, FDE, FDW, FKG, FKF	2250 - 2300 mm	680 ZŁ
	2350 - 2400 mm	1100 ZŁ
OŚCIEŻNICA ALUTHERM PREMIUM (DRZWI THERMO PREMIUM) / ALUTHERM (OPTIMA 60)		950 ZŁ
DRZWI DWUKOLOROWE		500 ZŁ
WKŁADKI W KLASIE 6 W SYSTEMIE JEDNEGO KLUCZA		180 ZŁ
OCHRONA GÓRNEGO SZYLDU (THERMO PREMIUM, OPTIMA)		30 ZŁ
KLAMKO - GAŁKA		50 ZŁ
KONTAKTRON		120 ZŁ
ROZMIAR 100E		350 ZŁ
SAMOZAMYKACZ UKRYTY (THERMO PREMIUM)		1100 ZŁ
	2150 - 2200 mm	330 ZŁ
	2250 - 2300 mm	680 ZŁ
	2350 - 2400 mm	1100 ZŁ
	ELEKTROZACZEP Z FUNKCJĄ DZIEŃ / NOC	250 ZŁ
	1800 mm	825 ZŁ
	1700 mm	800 ZŁ
	1500 mm	770 ZŁ
	1000 mm	715 ZŁ
	1800 mm	1 640 ZŁ
	1700 mm	1 620 ZŁ
	1500 mm	1 590 ZŁ
	1000 mm	1 540 ZŁ
	SKRACANIE DRZWI NS1, NS2, NS3, NS9 (10, 20, 30, 40 mm)	215 ZŁ
	NS4 (10, 20, 30, 40, 60, 80, 100 mm)	1 650 ZŁ
	ZESTAW TEDEE	1 650 ZŁ

* DOŚWIETLA ALUMINIOWE STAŁE: STRONY 88-89, PEŁNA LISTA WYPOSAŻENIA: STRONY 94-99

SZYBA



MATOWA

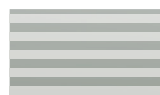

MATOWA PASKI PRZEZIERNE



MIRA STAR (SZYBA LUSTRZANA)

KOLORY DRZWI

ORZECH ALPEJSKI



FRR

MAHOŃ



FMA

ORZECH BRAZYLJSKI



FRB

JASNY ORZECH



FRP

ZŁOTY DĄB



FDE

WINCHESTER



FDW

DĄB TURNER



FDT

JASNY WENGE



FEJ

BIAŁY



FSB

STALOWOSZARY



FKZ

ANTRACYT



FKG

CIEMNY ANTRACYT



FKF

CZARNY



FKC



NS3 MILANO 10



NS4 MILANO 11



NS9 MILANO 12

KONFIGURACJA DRZWI THERMO PRIME 75



NS1B MILANO 8 B



STRONA WEWNĘTRZNA

OKUCIA KLAMKA-KLAMKA



THERMO PRIME



THERMO PREMIUM



OPTIMA

KLAMKA-GAŁKA



THERMO PREMIUM

POCHWYT

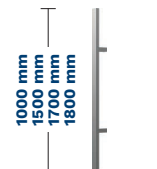

□ AMSTERDAM

○ MONTREAL

KOLORY OKUĆ

ANODA PLATYNA



ANODA SREBRNA



ANODA CZARNA



KOLORY DRZWI

ORZECH ALPEJSKI



MAHOŃ



ORZECH BRAZYLIJSKI



JASNY ORZECH



ZŁOTY DĄB



WINCHESTER



DĄB TURNER



JASNY WENGE



BIAŁY

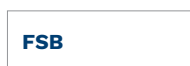

STALOWOSZARY



ANTRACYT



CIEMNY ANTRACYT

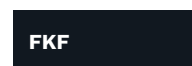

CZARNY





NS5B HANOVER 5 B



NS6 HANOVER 6

KOLORY DRZWI

ORZECH ALPEJSKI



FRR

MAHOŃ



FMA

ORZECH BRAZYLIJSKI



FRB

JASNY ORZECH



FRP

ZŁOTY DĄB



FDE

WINCHESTER



FDW

DĄB TURNER



FDT

JASNY WENGE



FEJ

BIAŁY



FSB

STALOWOSZARY



FKZ

ANTRACYT



FKG

CIEMNY ANTRACYT



FKF

CZARNY



FKC

ROZMIAR (THERMO PRIME, THERMO PREMIUM)	-	80	90N	90E	100E
ROZMIAR OPTIMA	80N	80	90N	90E	100E

MODEL	OPTIMA 60	THERMO PREMIUM 60	THERMO PREMIUM 75	THERMO PRIME 75
NS5 HANOVER 5	3 475 Zł	4 017 Zł	4 449 Zł	5 917 Zł
NS6 HANOVER 6	3 475 Zł	4 017 Zł	4 449 Zł	5 917 Zł
NS7 INNSBRUCK	3 717 Zł	4 182 Zł	4 614 Zł	6 082 Zł

WYPOSAŻENIE STANDARDOWE RC2

- SKRZYDŁO PRZESZKŁONE SPEŁNIAJĄCE WARUNKI PROGRAMU CZYSTE POWIETRZE
- 4 PRZYLGI SKRZYDŁA THERMO PREMIUM I THERMO PRIME, 3 PRZYLGI SZKRYDŁA OPTIMA
- THERMO PREMIUM OŚCIEŻNICA DUOTHERM / THERMO PRIME OŚCIEŻNICA ALUTHERM PRIME / OPTIMA OŚCIEŻNICA PERFOTHERM
- ZAWIASY REGULOWANE 3D Z OSŁONKAMI W KOLORZE OKUĆ THERMO PREMIUM I THERMO PRIME, ZAWIAS 2D Z OSŁONKAMI W KOLORZE OKUĆ DLA OPTIMA
- WZÓR DWUSTRONNY
- PRÓG ALUMINIOWY
- KOMPLET OKUĆ Z OCHRONĄ WKŁADKI
- SZYLDY DŁUGIE BERGEN THERMO PREMIUM, SZYLDY DZIELONE BERGEN THERMO PRIME, SZYLDY DZIELONE BLOK OPTIMA
- WKŁADKI W KLASIE 5, SYSTEM JEDNEGO KLUCZA DLA DRZWI THERMO PREMIUM I OPTIMA

DOPLĄTY

WYSOKOŚĆ NIESTANDARDOWA (THERMO PRIME)	2150 - 2200 mm	330 ZŁ
DOSTĘPNE KOLORY: FRP, FDE, FDW, FKG, FKF	2250 - 2300 mm	680 ZŁ
	2350 - 2400 mm	1100 ZŁ
OŚCIEŻNICA ALUTHERM PREMIUM (DRZWI THERMO PREMIUM) / ALUTHERM (OPTIMA 60)		950 ZŁ
DRZWI DWUKOLOROWE		500 ZŁ
WKŁADKI W KLASIE 6 W SYSTEMIE JEDNEGO KLUCZA		180 ZŁ
OCHRONA GÓRNEGO SZYLDU (THERMO PREMIUM, OPTIMA)		30 ZŁ
KLAMKO - GAŁKA		50 ZŁ
KONTAKTRON		120 ZŁ
ROZMIAR 100E		350 ZŁ
SAMOZAMYKACZ UKRYTY (THERMO PREMIUM)		1100 ZŁ
ELEKTROZACZEP Z FUNKCJĄ DZIEŃ / NOC		250 ZŁ
	1800 mm	825 ZŁ
POCHWYT AMSTERDAM / MONTREAL ZALECANY ELEKTROZACZEP	1700 mm	800 ZŁ
	1500 mm	770 ZŁ
	1000 mm	715 ZŁ
	1800 mm	1 640 ZŁ
POCHWYT Z PRZYCISKIEM AMSTERDAM / MONTREAL Z DOSTOSOWANIEM SKRZYDŁA ORAZ ELEKTROZACZEP	1700 mm	1 620 ZŁ
	1500 mm	1 590 ZŁ
	1000 mm	1 540 ZŁ
SKRACANIE DRZWI NS5 (10, 20, 30, 40, 60, 80, 100 mm), NS6 (10, 20, 30, 40 mm)		215 ZŁ
ZESTAW TEDEE		1 650 ZŁ

* DOŚWIETLA ALUMINIOWE STAŁE: STRONY 88-89, PEŁNA LISTA WYPOSAŻENIA: STRONY 94-99

SZYBA



MATOWA



MIRA STAR (SZYBA LUSTRZANA)



NS7 INNSBRUCK

KONFIGURACJA DRZWI THERMO PRIME 75



NS5B HANOVER 5 B



STRONA WEWNĘTRZNA

OKUCIA

KLAMKA-KLAMKA



THERMO PRIME



THERMO PREMIUM



OPTIMA

KLAMKA-GAŁKA



THERMO PREMIUM

POCHWYT

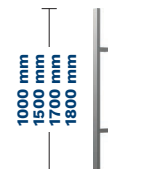

□ AMSTERDAM

○ MONTREAL

KOLORY OKUĆ

ANODA PLATYNA



ANODA SREBRNA



ANODA CZARNA



KOLORY DRZWI

ORZECH ALPEJSKI



MAHOŃ



ORZECH BRAZYLIIJSKI



JASNY ORZECH



ZŁOTY DĄB



WINCHESTER



DĄB TURNER



JASNY WENGE



BIAŁY



STALOWOSZARY



ANTRACYT



CIEMNY ANTRACYT



CZARNY





W00 PŁASKIE

ROZMIAR (THERMO PRIME, THERMO PREMIUM)	-	80	90N	90E	100E
ROZMIAR OPTIMA	80N	80	90N	90E	100E

MODEL	OPTIMA 50	OPTIMA 60	THERMO PREMIUM 60	THERMO PREMIUM 75	THERMO PRIME 75
W00 PŁASKIE	1 809 Zł	2 155 Zł	2 587 Zł	3 019 Zł	4 487 Zł

WYPOSAŻENIE STANDARDOWE RC2

- SKRZYDŁO SPEŁNIAJĄCE WARUNKI PROGRAMU CZYSTE POWIETRZE
- PRÓG ALUMINIOWY
- 4 PRZYLGI SKRZYDŁA THERMO PREMIUM I THERMO PRIME, 3 PRZYLGI SZKRYDŁA OPTIMA
- KOMPLET OKUĆ Z OCHRONĄ WKŁADKI
- THERMO PREMIUM OŚCIEŻNICA DUOTHERM / THERMO PRIME OŚCIEŻNICA ALUTHERM PRIME / OPTIMA 60 PERFOTHERM / OPTIMA 50 OŚCIEŻNICA STALOWA
- SZYLDY DŁUGIE BERGEN THERMO PREMIUM, SZYLDY DZIELONE BERGEN THERMO PRIME, SZYLDY DZIELONE BLOK OPTIMA
- ZAWIASY REGULOWANE 3D Z OSŁONKAMI W KOLORZE OKUĆ THERMO PREMIUM I THERMO PRIME, ZAWIAS 2D Z OSŁONKAMI W KOLORZE OKUĆ DLA OPTIMA
- WKŁADKI W KLASIE 5, SYSTEM JEDNEGO KLUCZA DLA DRZWI THERMO PREMIUM I OPTIMA

DOPLATY

WYSOKOŚĆ NIESTANDARDOWA (THERMO PRIME)	2150 - 2200 mm	330 ZŁ
DOSTĘPNE KOLORY: FRP, FDE, FDW, FKG, FKF	2250 - 2300 mm	680 ZŁ
	2350 - 2400 mm	1100 ZŁ
OŚCIEŻNICA ALUTHERM PREMIUM (DRZWI THERMO PREMIUM) / ALUTHERM (OPTIMA 60)	950 ZŁ	ROZMIAR 100E 350 ZŁ
OŚCIEŻNICA PERFOTHERM (OPTIMA 50)	500 ZŁ	ELEKTROZACZEP Z FUNKCJĄ DZIEŃ / NOC 250 ZŁ
DRZWI DWUKOLOROWE	500 ZŁ	1800 mm 825 ZŁ
PAKIET RC3	370 ZŁ	1700 mm 800 ZŁ
WKŁADKI W KLASIE 6 W SYSTEMIE JEDNEGO KLUCZA	180 ZŁ	1500 mm 770 ZŁ
OCHRONA GÓRNEGO SZYLDU (THERMO PREMIUM, OPTIMA)	30 ZŁ	1000 mm 715 ZŁ
KLAMKO - GAŁKA	50 ZŁ	1800 mm 1 640 ZŁ
KONTAKTRON	120 ZŁ	1700 mm 1 620 ZŁ
SAMOZAMYKACZ UKRYTY (THERMO PREMIUM)	1100 ZŁ	1500 mm 1 590 ZŁ
		1000 mm 1 540 ZŁ
		SKRACANIE DRZWI (10, 20, 30, 40, 60, 80, 100 mm) 215 ZŁ
		ZESTAW TEDEE 1 650 ZŁ

* DOŚWIETLA ALUMINIOWE STAŁE: STRONY 88-89, PEŁNA LISTA WYPOSAŻENIA: STRONY 94-99

KOLORY DRZWI

ORZECH ALPEJSKI



MAHOŃ



ORZECH BRAZYLIJSKI



JASNY ORZECH



ZŁOTY DĄB



WINCHESTER



DĄB TURNER



JASNY WENGE



BIAŁY



STALOWOSZARY



ANTRACYT



CIEMNY ANTRACYT



CZARNY





WOO PŁASKIE



STRONA WEWNĘTRZNA

KONFIGURACJA DRZWI THERMO PRIME 75



WOO PŁASKIE



STRONA WEWNĘTRZNA

OKUCIA

KLAMKA-KLAMKA



THERMO PRIME



THERMO PREMIUM



OPTIMA

KLAMKA-GAŁKA



THERMO PREMIUM

POCHWYT

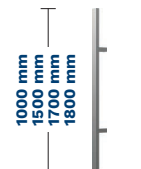

AMSTERDAM

MONTREAL

KOLORY OKUĆ

ANODA PŁATYNA



ANODA SREBRNA



ANODA CZARNA



KOLORY DRZWI

ORZECH ALPEJSKI



MAHOŃ



ORZECH BRAZYLJSKI



JASNY ORZECH



ZŁOTY DĄB



WINCHESTER



DĄB TURNER



JASNY WENGE



BIAŁY



STALOWOSZARY



ANTRACYT



CIEMNY ANTRACYT



CZARNY





SNU MILANO 4



SNUA MILANO 4A

ROZMIAR (MILANO 4, MILANO 4A)	80N	80	90N	90E	100E
ROZMIAR (MILANO 4B)	80N	80	90N	90E	100E

MODEL	OPTIMA 50	OPTIMA 60
SNU MILANO 4	-	3 475 Zł
SNUA MILANO 4A	-	3 717 Zł
SNUB MILANO 4B	-	3 717 Zł

WYPOSAŻENIE STANDARDOWE RC2

- SKRZYDŁO PRZESZKLONE SPEŁNIAJĄCE WARUNKI PROGRAMU CZYSTE POWIETRZE
- 3 PRZYLGI SKRZYDŁA
- OPTIMA 60 OŚCIEŻNICA PERFOTHERM
- ZAWIASY 2D Z OSŁONKAMI W KOLORZE OKUĆ
- WZÓR DWUSTRONNY
- PRÓG ALUMINIOWY
- KOMPLET OKUĆ Z OCHRONĄ WKŁADKI
- SZYLDY DZIELONE BERGEN I BLOK
- WKŁADKI W KLASIE 5, SYSTEM JEDNEGO KLUCZA

DOPLATY

OŚCIEŻNICA ALUTHERM OPTIMA	950 ZŁ		1800 mm	825 ZŁ
DRZWI DWUKOLOROWE	500 ZŁ	POCHWYT AMSTERDAM / MONTREAL ZALECANY ELEKTROZACZEP	1700 mm	800 ZŁ
WKŁADKI W KLASIE 6 W SYSTEMIE JEDNEGO KLUCZA	180 ZŁ		1500 mm	770 ZŁ
			1000 mm	715 ZŁ
OCHRONA GÓRNEGO SZYLDU	30 ZŁ	POCHWYT Z PRZYCISKIEM AMSTERDAM / MONTREAL Z DOSTOSOWANIEM SKRZYDŁA ORAZ ELEKTROZACZPEM	1800 mm	1 640 ZŁ
			1700 mm	1 620 ZŁ
KLAMKO - GAŁKA	50 ZŁ		1500 mm	1 590 ZŁ
KONTAKTRON	120 ZŁ		1000 mm	1 540 ZŁ
ROZMIAR 100E	350 ZŁ	SKRACANIE DRZWI (10, 20, 30, 40, 60, 80, 100 mm)		215 ZŁ
ELEKTROZACZEP Z FUNKCJĄ DZIEŃ / NOC	250 ZŁ	ZESTAW TEDEE		1 650 ZŁ

* DOŚWIETLA ALUMINIOWE STAŁE: STRONY 88-89, PEŁNA LISTA WYPOSAŻENIA: STRONY 94-99

SZYBA



MATOWA



**MATOWA
PASKI PRZEZIERNE**



GRAFIT



MIRA STAR (SZYBA LUSTRZANA)

KOLORY DRZWI

ORZECH ALPEJSKI



FRR

MAHOŃ



FMA

ORZECH BRAZYLJSKI



FRB

JASNY ORZECH



FRP

ZŁOTY DĄB



FDE

WINCHESTER



FDW

DĄB TURNER



FDT

JASNY WENGE



FEJ

BIAŁY

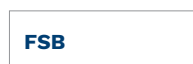

FSB

STALOWOSZARY



FKZ

ANTRACYT



FKG

CIEMNY ANTRACYT



FKF

CZARNY



FKC



SNUB MILANO 4B

OKUCIA

KLAMKA-KLAMKA



KLAMKA-GAŁKA



POCHWYT



□ AMSTERDAM

○ MONTREAL

KOLORY OKUĆ

ANODA PLATYNA



ANODA SREBRNA



ANODA CZARNA



KOLORY DRZWI

ORZECH ALPEJSKI



MAHOŃ



ORZECH BRAZYLIJSKI



JASNY ORZECH



ZŁOTY DĄB



WINCHESTER



DĄB TURNER



JASNY WENGE



BIAŁY



STALOWOSZARY



ANTRACYT



CIEMNY ANTRACYT



CZARNY





NT1 TURYN 1



NT1B TURYN 1B

KOLORY DRZWI

ORZECH ALPEJSKI



FRR

MAHOŃ



FMA

ORZECH BRAZYLIJSKI



FRB

JASNY ORZECH

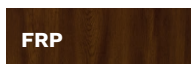

FRP

ZŁOTY DĄB



FDE

WINCHESTER



FDW

DĄB TURNER



FDT

JASNY WENGE



FEJ

BIAŁY



FSB

STALOWOSZARY



FKZ

ANTRACYT



FKG

CIEMNY ANTRACYT



FKF

CZARNY



FKC

ROZMIAR

ROZMIAR	80N	80	90N	90E	100E
---------	-----	----	-----	-----	------

MODEL

MODEL	OPTIMA 50	OPTIMA 60
NT1 TURYN 1	-	3 475 Zł
NT1B TURYN 1B	-	3 475 Zł
NT2 TURYN 2	-	3 475 Zł
NT2B TURYN 2B	-	3 475 Zł

WYPOSAŻENIE STANDARDOWE RC2

- SKRZYDŁO PRZESZKLONE SPEŁNIAJĄCE WARUNKI PROGRAMU CZYSTE POWIETRZE
- 3 PRZYLGI SZKRYDŁA
- OPTIMA 60 OŚCIEŻNICA PERFOTHERM
- ZAWIASY 2D Z OSŁONKAMI W KOLORZE OKUĆ
- WZÓR DWUSTRONNY
- PRÓG ALUMINIOWY
- KOMPLET OKUĆ Z OCHRONĄ WKŁADKI
- SZYLDY DZIELONE BERGEN I BLOK
- WKŁADKI W KLASIE 5, SYSTEM JEDNEGO KLUCZA

DOPLATY

OŚCIEŻNICA ALUTHERM OPTIMA	950 Zł		1800 mm	825 Zł
DRZWI DWUKOLOROWE	500 Zł		1700 mm	800 Zł
WKŁADKI W KLASIE 6 W SYSTEMIE JEDNEGO KLUCZA	180 Zł		1500 mm	770 Zł
			1000 mm	715 Zł
OCHRONA GÓRNEGO SZYLDU	30 Zł		1800 mm	1 640 Zł
KLAMKO - GAŁKA	50 Zł		1700 mm	1 620 Zł
KONTAKTRON	120 Zł		1500 mm	1 590 Zł
ROZMIAR 100E	350 Zł		1000 mm	1 540 Zł
ELEKTROZACZEP Z FUNKCJĄ DZIEŃ / NOC	250 Zł	ZESTAW TEDEE		1 650 Zł

* DOŚWIETLA ALUMINIOWE STAŁE: STRONY 88-89, PEŁNA LISTA WYPOSAŻENIA: STRONY 94-99

SZYBA



MATOWA



MATOWA
PASKI PRZEZIERNE



GRAFIT





NT2 TURYN 2



NT2B TURYN 2B

KOLORY DRZWI

ORZECH ALPEJSKI



MAHOŃ



ORZECH BRAZYLIIJSKI



JASNY ORZECH



ZŁOTY DĄB



WINCHESTER



DĄB TURNER



JASNY WENGE



BIAŁY



STALOWOSZARY



ANTRACYT



CIEMNY ANTRACYT



CZARNY



OKUCIA

KLAMKA-KLAMKA



KLAMKA-GAŁKA



POCHWYT



□ AMSTERDAM

○ MONTREAL

KOLORY OKUĆ

ANODA PLATYNA



ANODA SREBRNA



ANODA CZARNA



TEMPO

BERGAMO / NICEA / BERLIN



SOJ BERGAMO 2



SJ9 NICEA 9

KOLORY DRZWI

ORZECH ALPEJSKI



FRR

MAHOŃ



FMA

ORZECH BRAZYLJSKI



FRB

JASNY ORZECH



FRP

ZŁOTY DĄB



FDE

WINCHESTER



FDW

DĄB TURNER



FDT

JASNY WENGE



FEJ

BIAŁY



FSB

STALOWOSZARY



FKZ

ANTRACYT



FKG

CIEMNY ANTRACYT



FKF

CZARNY



FKC

ROZMIAR

	80N	80	90N	90E	100E
--	-----	----	-----	-----	------

MODEL

	OPTIMA 50	OPTIMA 60
SOJ BERGAMO 2	-	3 717 Zł
SJ9 NICEA 9	-	3 475 Zł
SBE BERLIN	-	3 717 Zł

WYPOSAŻENIE STANDARDOWE RC2

- SKRZYDŁO PRZESZKŁONE SPEŁNIAJĄCE WARUNKI PROGRAMU CZYSTE POWIETRZE
- 3 PRZYLGI SKRZYDŁA
- OPTIMA 60 OŚCIEŻNICA PERFOTHERM
- ZAWIASY 2D Z OSŁONKAMI W KOLORZE OKUĆ
- WZÓR DWUSTRONNY
- PRÓG ALUMINIOWY
- KOMPLET OKUĆ Z OCHRONĄ WKŁADKI
- SZYLDY DZIELONE BERGEN I BLOK
- WKŁADKI W KLASIE 5, SYSTEM JEDNEGO KLUCZA

DOPLĄTY

OŚCIEŻNICA ALUTHERM OPTIMA	950 Zł		1800 mm	825 Zł
DRZWI DWUKOLOROWE	500 Zł		1700 mm	800 Zł
WKŁADKI W KLASIE 6 W SYSTEMIE JEDNEGO KLUCZA	180 Zł	POCHWYT AMSTERDAM / MONTREAL ZALECANY ELEKTROZACZEP	1500 mm	770 Zł
			1000 mm	715 Zł
OCHRONA GÓRNEGO SZYLDU	30 Zł	POCHWYT Z PRZYCISKIEM AMSTERDAM / MONTREAL Z DOSTOSOWANIEM SKRZYDŁA ORAZ ELEKTROZACZPEM	1800 mm	1 640 Zł
			1700 mm	1 620 Zł
KLAMKO - GAŁKA	50 Zł		1500 mm	1 590 Zł
KONTAKTRON	120 Zł		1000 mm	1 540 Zł
ROZMIAR 100E	350 Zł	SKRACANIE DRZWI SJ9 (10, 20, 30, 40 mm)		215 Zł
ELEKTROZACZEP Z FUNKCJĄ DZIEŃ / NOC	250 Zł	SBE (10, 20, 30, 40, 60, 80, 100 mm)		
		ZESTAW TEDEE		1 650 Zł

* DOŚWIETLA ALUMINIOWE STAŁE: STRONY 88-89, PEŁNA LISTA WYPOSAŻENIA: STRONY 94-99

SZYBA (BERGAMO / NICEA)



MATOWA

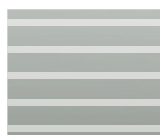

MATOWA PASKI PRZEZIERNE



MIRA STAR (SZYBA LUSTRZANA)



SBE BERLIN

SZYBA (BERLIN)



MATOWA



REFLEKS BRĄZ

KOLORY DRZWI

ORZECH ALPEJSKI



FRR

MAHOŃ



FMA

ORZECH BRAZYLIJSKI



FRB

JASNY ORZECH



FRP

ZŁOTY DĄB



FDE

WINCHESTER



FDW

DĄB TURNER



FDT

JASNY WENGE



FEJ

BIAŁY



FSB

STALOWOSZARY



FKZ

ANTRACYT



FKG

CIEMNY ANTRACYT



FKF

CZARNY



FKC

OKUCIA

KLAMKA-KLAMKA



KLAMKA-GAŁKA



POCHWYT



AMSTERDAM

MONTREAL

KOLORY OKUĆ

ANODA PLATYNA



ANODA SREBRNA



ANODA CZARNA





ST4 UPPSALA 1
(tłoczenie bez insertów)



ST4A UPPSALA 1A (inserty inox)

ROZMIAR

80N	80	90N	90E	100E
-----	----	-----	-----	------

MODEL

OPTIMA 50

OPTIMA 60

ST4 UPPSALA 1	2 059 Zł	2 405 Zł
ST4A UPPSALA 1A	2 469 Zł	2 815 Zł
ST5 UPPSALA 2	2 059 Zł	2 405 Zł
ST5A UPPSALA 2A	2 469 Zł	2 815 Zł

WYPOSAŻENIE STANDARDOWE RC2

- SKRZYDŁO SPEŁNIAJĄCE WARUNKI PROGRAMU CZYSTE POWIETRZE
- 3 PRZYLGI SZKRZYDŁA
- OPTIMA 50 OŚCIEŻNICA STALOWA, OPTIMA 60 OŚCIEŻNICA PERFOTHERM
- ZAWIASY 2D Z OSŁONKAMI W KOLORZE OKUĆ
- WZÓR DWUSTRONNY
- PRÓG ALUMINIOWY
- KOMPLET OKUĆ Z OCHRONĄ WKŁADKI
- SZYLDY DZIELONE BERGEN I BLOK
- WKŁADKI W KLASIE 5, SYSTEM JEDNEGO KLUCZA

DOPLĄTY

OŚCIEŻNICA ALUTHERM OPTIMA (DRZWI OPTIMA 60)	950 ZŁ	ROZMIAR 100E	350 ZŁ
OŚCIEŻNICA STALOWA PERFOTHERM OPTIMA (DRZWI OPTIMA 50)	120 ZŁ	ELEKTROZACZEP Z FUNKCJĄ DZIEŃ / NOC	250 ZŁ
DRZWI DWUKOLOROWE	500 ZŁ	1800 mm	825 ZŁ
PAKIET RC3	370 ZŁ	1700 mm	800 ZŁ
WKŁADKI W KLASIE 6 W SYSTEMIE JEDNEGO KLUCZA	180 ZŁ	1500 mm	770 ZŁ
OCHRONA GÓRNEGO SZYLDU	30 ZŁ	1000 mm	715 ZŁ
KLAMKO - GAŁKA	50 ZŁ	1800 mm	1 640 ZŁ
KONTAKTRON	120 ZŁ	1700 mm	1 620 ZŁ
		1500 mm	1 590 ZŁ
		1000 mm	1 540 ZŁ
		ZESTAW TEDEE	1 650 ZŁ

* DOŚWIETLA ALUMINIOWE STAŁE: STRONY 88-89, PEŁNA LISTA WYPOSAŻENIA: STRONY 94-99

KOLORY DRZWI

ORZECH ALPEJSKI

MAHOŃ

ORZECH BRAZYLJSKI

JASNY ORZECH

ZŁOTY DĄB

WINCHESTER

DĄB TURNER

FRR

FMA

FRB

FRP

FDE

FDW

FDT

JASNY WENGE

BIAŁY

STALOWOSZARY

ANTRACYT

CIEMNY ANTRACYT

CZARNY

FEJ

FSB

FKZ

FKG

FKF

FKC



ST5 UPPSALA 2
(tłoczenie bez insertów)



ST5A UPPSALA 2A (inserty inox)

OKUCIA

KLAMKA-KLAMKA



KLAMKA-GAŁKA



POCHWYT



□ AMSTERDAM

○ MONTREAL

KOLORY OKUĆ

ANODA PLATYNA



ANODA SREBRNA



ANODA CZARNA



KOLORY DRZWI

ORZECH ALPEJSKI



MAHOŃ



ORZECH BRAZYLIJSKI



JASNY ORZECH



ZŁOTY DĄB



WINCHESTER



DĄB TURNER



JASNY WENGE



BIAŁY



STALOWOSZARY



ANTRACYT



CIEMNY ANTRACYT



CZARNY





TML TOKIO 1
(tłoczenie bez insertów)



TMLA TOKIO 1A (inserty inox)

ROZMIAR

80N	80	90N	90E	100E
-----	----	-----	-----	------

MODEL

OPTIMA 50

OPTIMA 60

TML TOKIO 1	2 059 Zł	2 405 Zł
TMLA TOKIO 1A	2 469 Zł	2 815 Zł
TMM TOKIO 2	2 059 Zł	2 405 Zł
TMMA TOKIO 2A	2 469 Zł	2 815 Zł

WYPOSAŻENIE STANDARDOWE RC2

- SKRZYDŁO SPEŁNIAJĄCE WARUNKI PROGRAMU CZYSTE POWIETRZE
- 3 PRZYLGI SZKRYDŁA
- OPTIMA 50 OŚCIEŻNICA STALOWA, OPTIMA 60 OŚCIEŻNICA PERFOTHERM
- ZAWIASY 2D Z OSŁONKAMI W KOLORZE OKUĆ
- WZÓR DWUSTRONNY
- PRÓG ALUMINIOWY
- KOMPLET OKUĆ Z OCHRONĄ WKŁADKI
- SZYLDY DZIELONE BERGEN I BLOK
- WKŁADKI W KLASIE 5, SYSTEM JEDNEGO KLUCZA

DOPLĄTY

OŚCIEŻNICA ALUTHERM OPTIMA (DRZWI OPTIMA 60)	950 ZŁ	ROZMIAR 100E	350 ZŁ
OŚCIEŻNICA STALOWA PERFOTHERM OPTIMA (DRZWI OPTIMA 50)	120 ZŁ	ELEKTROZACZEP Z FUNKCJĄ DZIEŃ / NOC	250 ZŁ
DRZWI DWUKOLOROWE	500 ZŁ	1800 mm	825 ZŁ
PAKIET RC3	370 ZŁ	1700 mm	800 ZŁ
WKŁADKI W KLASIE 6 W SYSTEMIE JEDNEGO KLUCZA	180 ZŁ	1500 mm	770 ZŁ
OCHRONA GÓRNEGO SZYLDU	30 ZŁ	1000 mm	715 ZŁ
KLAMKO - GAŁKA	50 ZŁ	1800 mm	1 640 ZŁ
KONTAKTRON	120 ZŁ	1700 mm	1 620 ZŁ
		1500 mm	1 590 ZŁ
		1000 mm	1 540 ZŁ
		ZESTAW TEDEE	1 650 ZŁ

* DOŚWIETLA ALUMINIOWE STAŁE: STRONY 88-89, PEŁNA LISTA WYPOSAŻENIA: STRONY 94-99

KOLORY DRZWI

ORZECH ALPEJSKI

MAHOŃ

ORZECH BRAZYLJSKI

JASNY ORZECH

ZŁOTY DĄB

WINCHESTER

DĄB TURNER

FRR

FMA

FRB

FRP

FDE

FDW

FDT

JASNY WENGE

BIAŁY

STALOWOSZARY

ANTRACYT

CIEMNY ANTRACYT

CZARNY

FEJ

FSB

FKZ

FKG

FKF

FKC



TMM TOKIO 2
(tłoczenie bez insertów)



TMM TOKIO 2A (inserty inox)

OKUCIA

KLAMKA-KLAMKA



KLAMKA-GAŁKA



POCHWYT



□ AMSTERDAM

○ MONTREAL

KOLORY OKUĆ

ANODA PLATYNA



ANODA SREBRNA



ANODA CZARNA



KOLORY DRZWI

ORZECH ALPEJSKI



FRR

MAHOŃ



FMA

ORZECH BRAZYLIJSKI



FRB

JASNY ORZECH



FRP

ZŁOTY DĄB



FDE

WINCHESTER



FDW

DĄB TURNER



FDT

JASNY WENGE



FEJ

BIAŁY



FSB

STALOWOSZARY



FKZ

ANTRACYT



FKG

CIEMNY ANTRACYT



FKF

CZARNY



FKC

TEMPO RYGA / LUND / ASPEN



ST8 RYGA



ST9 LUND

KOLORY DRZWI

ORZECH ALPEJSKI



MAHOŃ



ORZECH BRAZYLJSKI



JASNY ORZECH



ZŁOTY DĄB



WINCHESTER



DĄB TURNER



JASNY WENGE



BIAŁY

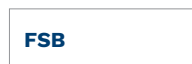

STALOWOSZARY



ANTRACYT



CIEMNY ANTRACYT



CZARNY



ROZMIAR

ROZMIAR	80N	80	90N	90E	100E
---------	-----	----	-----	-----	------

MODEL

MODEL	OPTIMA 50	OPTIMA 60
ST8 RYGA	2 469 Zł	2 815 Zł
ST9 LUND	2 469 Zł	2 815 Zł
WBA ASPEN 1	2 059 Zł	2 405 Zł
TN7 ASPEN 2	2 469 Zł	2 815 Zł
TN7B ASPEN 2B	2 469 Zł	2 815 Zł

WYPOSAŻENIE STANDARDOWE RC2

- SKRZYDŁO SPEŁNIAJĄCE WARUNKI PROGRAMU CZYSTE POWIETRZE
- 3 PRZYLGI SZKRYDŁA
- OPTIMA 50 OŚCIEŻNICA STALOWA, OPTIMA 60 OŚCIEŻNICA PERFOTHERM
- ZAWIASY 2D Z OSŁONKAMI W KOLORZE OKUĆ
- WZÓR DWUSTRONNY
- PRÓG ALUMINIOWY
- KOMPLET OKUĆ Z OCHRONĄ WKŁADKI
- SZYLDY DZIELONE BERGEN I BLOK
- WKŁADKI W KLASIE 5, SYSTEM JEDNEGO KLUCZA

DOPLATY

OŚCIEŻNICA ALUTHERM OPTIMA (DRZWI OPTIMA 60)	950 ZŁ	ROZMIAR 100E	350 ZŁ
OŚCIEŻNICA STALOWA PERFOTHERM OPTIMA (DRZWI OPTIMA 50)	120 ZŁ	POCHWYT AMSTERDAM / MONTREAL ZALECANY ELEKTROZACZEP	1800 mm 825 ZŁ 1700 mm 800 ZŁ 1500 mm 770 ZŁ 1000 mm 715 ZŁ
DRZWI DWUKOLOROWE	500 ZŁ	POCHWYT Z PRZYCISKIEM AMSTERDAM / MONTREAL Z DOSTOSOWANIEM SKRZYDŁA ORAZ ELEKTROZACZPEM	1800 mm 1 640 ZŁ 1700 mm 1 620 ZŁ 1500 mm 1 590 ZŁ 1000 mm 1 540 ZŁ
PAKIET RC3	370 ZŁ	SKRACANIE DRZWI WBA, TN7, TN7B (10, 20, 30, 40, 60, 80, 100 mm)	215 ZŁ
WKŁADKI W KLASIE 6 W SYSTEMIE JEDNEGO KLUCZA	180 ZŁ	ZESTAW TEDEE	1 650 ZŁ
OCHRONA GÓRNEGO SZYLDU	30 ZŁ		
KLAMKO - GAŁKA	50 ZŁ		
KONTAKTRON	120 ZŁ		
ELEKTROZACZEP Z FUNKCJĄ DZIEŃ / NOC	250 ZŁ		

* DOŚWIETLA ALUMINIOWE STAŁE: STRONY 88-89, PEŁNA LISTA WYPOSAŻENIA: STRONY 94-99



WBA ASPEN 1



TN7 ASPEN 2



TN7B ASPEN 2B

OKUCIA

KLAMKA-KLAMKA



KLAMKA-GAŁKA



POCHWYT



□ AMSTERDAM

○ MONTREAL

KOLORY OKUĆ

ANODA PLATYNA



ANODA SREBRNA



ANODA CZARNA



KOLORY DRZWI

ORZECH ALPEJSKI



MAHOŃ



ORZECH BRAZYLIJSKI



JASNY ORZECH



ZŁOTY DĄB



WINCHESTER



DĄB TURNER



JASNY WENGE



BIAŁY

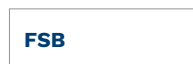

STALOWOSZARY



ANTRACYT



CIEMNY ANTRACYT



CZARNY





SR3 TROMSO



SR4 TROMSO 1

KOLORY DRZWI

ORZECH ALPEJSKI



FRR

MAHOŃ



FMA

ORZECH BRAZYLJSKI



FRB

JASNY ORZECH



FRP

ZŁOTY DĄB



FDE

WINCHESTER



FDW

DĄB TURNER



FDT

JASNY WENGE



FEJ

BIAŁY



FSB

STALOWOSZARY



FKZ

ANTRACYT



FKG

CIEMNY ANTRACYT



FKF

CZARNY



FKC

ROZMIAR

80N	80	90N	90E	100E
-----	----	-----	-----	------

MODEL

OPTIMA 50

OPTIMA 60

SR3 TROMSO	2 059 Zł	2 405 Zł
SR4 TROMSO 1	2 059 Zł	2 405 Zł
SR5 TROMSO 2	2 059 Zł	2 405 Zł

WYPOSAŻENIE STANDARDOWE RC2

- SKRZYDŁO SPEŁNIAJĄCE WARUNKI PROGRAMU CZYSTE POWIETRZE
- 3 PRZYLGI SKRZYDŁA
- OPTIMA 50 OŚCIEŻNICA STAŁOWA, OPTIMA 60 OŚCIEŻNICA PERFOTHERM
- ZAWIASY 2D Z OSŁONKAMI W KOLORZE OKUCIA
- WZÓR DWUSTRONNY
- PRÓG ALUMINIOWY
- KOMPLET OKUCIA Z OCHRONĄ WKŁADKI
- SZYLDY DZIELONE BERGEN I BLOK
- WKŁADKI W KLASIE 5, SYSTEM JEDNEGO KLUCZA

DOPLATY

OŚCIEŻNICA ALUTHERM OPTIMA (DRZWI OPTIMA 60)	950 Zł	ROZMIAR 100E	350 Zł
		1800 mm	825 Zł
OŚCIEŻNICA STAŁOWA PERFOTHERM OPTIMA (DRZWI OPTIMA 50)	120 Zł	POCHWYT AMSTERDAM / MONTREAL ZALECANY ELEKTROZACZEP	1700 mm 800 Zł
		1500 mm	770 Zł
DRZWI DWUKOLOROWE	500 Zł		1000 mm 715 Zł
PAKIET RC3	370 Zł		1800 mm 1 640 Zł
WKŁADKI W KLASIE 6 W SYSTEMIE JEDNEGO KLUCZA	180 Zł	POCHWYT Z PRZYCISKIEM AMSTERDAM / MONTREAL Z DOSTOSOWANIEM SKRZYDŁA ORAZ ELEKTROZACZEP	1700 mm 1 620 Zł
OCHRONA GÓRNEGO SZYLDU	30 Zł		1500 mm 1 590 Zł
KLAMKO - GAŁKA	50 Zł		1000 mm 1 540 Zł
KONTAKTRON	120 Zł	SKRACANIE DRZWI SR4 (10, 20, 30, 40 mm)	215 Zł
ELEKTROZACZEP Z FUNKCJĄ DZIEŃ / NOC	250 Zł	ZESTAW TEDEE	1 650 Zł

* DOŚWIETLA ALUMINIOWE STAŁE: STRONY 88-89, PEŁNA LISTA WYPOSAŻENIA: STRONY 94-99



SR5 TROMSO 2

OKUCIA

KLAMKA-KLAMKA

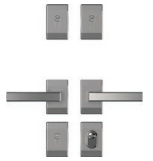

KLAMKA-GAŁKA



POCHWYT

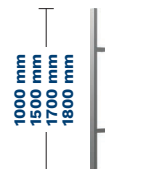

□ AMSTERDAM

○ MONTREAL

KOLORY OKUĆ

ANODA PLATYNA



ANODA SREBRNA



ANODA CZARNA



KOLORY DRZWI

ORZECH ALPEJSKI



FRR

MAHOŃ



FMA

ORZECH BRAZYLIJSKI



FRB

JASNY ORZECH



FRP

ZŁOTY DĄB



FDE

WINCHESTER



FDW

DĄB TURNER



FDT

JASNY WENGE



FEJ

BIAŁY



FSB

STALOWOSZARY



FKZ

ANTRACYT



FKG

CIEMNY ANTRACYT



FKF

CZARNY



FKC

CLASSIC MODENA / RAVENA

GERDA®



W76 MODENA



W77 MODENA 2

ROZMIAR	80	90N	90E
---------	----	-----	-----

MODEL	OPTIMA 50	OPTIMA 60
W76 MODENA	-	3 060 Zł
W77 MODENA 2	-	3 060 Zł
W78 MODENA 3	-	3 060 Zł
WDR RAVENA	2 109 Zł	2 455 Zł

WYPOSAŻENIE STANDARDOWE RC2

- SKRZYDŁO PRZESZKLONE SPEŁNIAJĄCE WARUNKI PROGRAMU CZYSTE POWIETRZE
- 3 PRZYLGI SZKRYDŁA
- OPTIMA 50 OŚCIEŻNICA STALOWA, OPTIMA 60 OŚCIEŻNICA PERFOTHERM
- ZAWIAS 2D Z OSŁONKAMI W KOLORZE OKUĆ
- WZÓR DWUSTRONNY
- PRÓG ALUMINIOWY
- KOMPLET OKUĆ Z OCHRONĄ WKŁADKI
- SZYLDY DZIELONE BERGEN I BLOK
- WKŁADKI W KLASIE 5, SYSTEM JEDNEGO KLUCZA
- GŁĘBOKIE TŁOCZENIE

DOPLĄTY

OŚCIEŻNICA ALUTHERM OPTIMA (DRZWI OPTIMA 60)	950 ZŁ	OCHRONA GÓRNEGO SZYLDU	30 ZŁ
OŚCIEŻNICA STALOWA PERFOTHERM OPTIMA (DRZWI OPTIMA 50)	120 ZŁ	KLAMKO - GAŁKA	50 ZŁ
DRZWI DWUKOLOROWE	500 ZŁ	KONTAKTRON	120 ZŁ
PAKIET RC3 (OPTIMA 60 WZÓR WDR)	370 ZŁ	ELEKTROZACZEP Z FUNKCJĄ DZIEŃ / NOC	250 ZŁ
WKŁADKI W KLASIE 6 W SYSTEMIE JEDNEGO KLUCZA	180 ZŁ	SKRACANIE DRZWI (10, 20, 30, 40, 60, 80, 100 mm)	215 ZŁ
		ZESTAW TEDEE	1 650 ZŁ

* DOŚWIETLA ALUMINIOWE STAŁE: STRONY 88-89, PEŁNA LISTA WYPOSAŻENIA: STRONY 94-99

SZYBA



MATOWA



REFLEKS BRĄZ



MIRA STAR (SZYBA LUSTRZANA)

KOLORY DRZWI

ORZECH ALPEJSKI



MAHOŃ



ORZECH BRAZyliJSKI JASNY ORZECH



ZŁOTY DĄB



WINCHESTER



BIAŁY



STALOWOSZARY



ANTRACYT



CIEMNY ANTRACYT





W78 MODENA 3



WDR RAVENA

OKUCIA KLAMKA-KLAMKA



KLAMKA-GAŁKA



KOLORY OKUĆ

ANODA PLATYNA



ANODA SREBRNA



ANODA CZARNA



KOLORY DRZWI

ORZECH ALPEJSKI



MAHOŃ

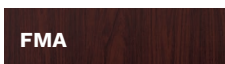

ORZECH BRAZYLIJSKI



JASNY ORZECH



ZŁOTY DĄB



WINCHESTER



BIAŁY



STALOWOSZARY



ANTRACYT



CIEMNY ANTRACYT





WJ1 NICEA 5

ROZMIAR	80	90N	90E
---------	----	-----	-----

MODEL	OPTIMA 50	OPTIMA 60
WJ1 NICEA 5	-	3 365 Zł
W23 OLYMPIA	-	3 060 Zł

WYPOSAŻENIE STANDARDOWE RC2

- SKRZYDŁO PRZESZKŁONE SPEŁNIAJĄCE WARUNKI PROGRAMU CZYSTE POWIETRZE
- 3 PRZYLGI SZKRYDŁA
- OPTIMA 60 OŚCIEŻNICA PERFOTHERM
- ZAWIAS 2D Z OSŁONKAMI W KOLORZE OKUĆ
- WZÓR DWUSTRONNY
- PRÓG ALUMINIOWY
- KOMPLET OKUĆ Z OCHRONĄ WKŁADKI
- SZYLDY DZIELONE BERGEN I BLOK
- WKŁADKI W KLASIE 5, SYSTEM JEDNEGO KLUCZA
- GŁĘBOKIE TŁOCZENIE

DOPŁATY

OŚCIEŻNICA ALUTHERM OPTIMA (DRZWI OPTIMA 60)	950 ZŁ	OCHRONA GÓRNEGO SZYLDU	30 ZŁ
OŚCIEŻNICA STALOWA PERFOTHERM OPTIMA (DRZWI OPTIMA 50)	120 ZŁ	KLAMKO - GAŁKA	50 ZŁ
DRZWI DWUKOLOROWE	500 ZŁ	KONTAKTRON	120 ZŁ
ROZMIAR 100E (WZÓR W23)	370 ZŁ	ELEKTROZACZEP Z FUNKCJĄ DZIEŃ / NOC	250 ZŁ
WKŁADKI W KLASIE 6 W SYSTEMIE JEDNEGO KLUCZA	180 ZŁ	SKRACANIE DRZWI (10, 20, 30, 40, 60, 80, 100 mm)	215 ZŁ
		ZESTAW TEDEE	1 650 ZŁ

* DOŚWIETLA ALUMINIOWE STAŁE: STRONY 88-89, PEŁNA LISTA WYPOSAŻENIA: STRONY 94-99

SZYBA



MATOWA



GRAFIT



MIRA STAR (SZYBA LUSTRZANA)

KOLORY DRZWI

ORZECH ALPEJSKI



FRR

MAHOŃ



FMA

ORZECH BRAZyliJSKI



FRB

JASNY ORZECH



FRP

ZŁOTY DĄB



FDE

WINCHESTER



FDW

BIAŁY



FSB

STALOWOSZARY



FKZ

ANTRACYT



FKG

CIEMNY ANTRACYT



FKF



W23 OLYMPIA

OKUCIA

KLAMKA-KLAMKA



KLAMKA-GAŁKA



KOLORY OKUĆ

ANODA PLATYNA



ANODA SREBRNA



ANODA CZARNA



KOLORY DRZWI

ORZECH ALPEJSKI



MAHOŃ

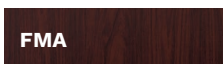

ORZECH BRAZYLIJSKI JASNY ORZECH



ZŁOTY DĄB



WINCHESTER



BIAŁY



STALOWOSZARY



ANTRACYT



CIEMNY ANTRACYT





W91 WERONA



W94 WERONA 1

ROZMIAR

80	90N	90E
----	-----	-----

MODEL

	OPTIMA 50	OPTIMA 60
W91 WERONA	2 109 Zł	2 455 Zł
W94 WERONA 1	-	2 755 Zł
W93 WERONA 3	-	3 060 Zł
W6A WERONA 4	-	3 060 Zł
WQA WERONA 5	-	3 060 Zł

WYPOSAŻENIE STANDARDOWE RC2

- SKRZYDŁO PRZESZKLONE SPEŁNIAJĄCE WARUNKI PROGRAMU CZYSTE POWIETRZE
- 3 PRZYLGI SZKRYDŁA
- OPTIMA 50 OŚCIEŻNICA STALOWA, OPTIMA 60 OŚCIEŻNICA PERFOTHERM
- ZAWIAS 2D Z OSŁONKAMI W KOLORZE OKUĆ
- WZÓR DWUSTRONNY
- PRÓG ALUMINIOWY
- KOMPLET OKUĆ Z OCHRONĄ WKŁADKI
- SZYLDY DZIELONE BERGEN I BLOK
- WKŁADKI W KLASIE 5, SYSTEM JEDNEGO KLUCZA
- GŁĘBOKIE TŁOCZENIE

DOPLĄTY

OŚCIEŻNICA ALUTHERM OPTIMA (DRZWI OPTIMA 60)	950 ZŁ	OCHRONA GÓRNEGO SZYLDU	30 ZŁ
OŚCIEŻNICA STALOWA PERFOTHERM OPTIMA (DRZWI OPTIMA 50)	120 ZŁ	KLAMKO - GAŁKA	50 ZŁ
DRZWI DWUKOLOROWE	500 ZŁ	KONTAKTRON	120 ZŁ
PAKIET RC3 (OPTIMA 60 WZÓR W91)	370 ZŁ	ELEKTROZACZEP Z FUNKCJĄ DZIEŃ / NOC	250 ZŁ
WKŁADKI W KLASIE 6 W SYSTEMIE JEDNEGO KLUCZA	180 ZŁ	SKRACANIE DRZWI (10, 20, 30, 40, 60, 80, 100 mm)	215 ZŁ
		ZESTAW TEDEE	1 650 ZŁ

* DOŚWIETLA ALUMINIOWE STAŁE: STRONY 88-89, PEŁNA LISTA WYPOSAŻENIA: STRONY 94-99

SZYBA



MATOWA



REFLEKS BRĄZ



MIRA STAR (SZYBA LUSTRZANA)

KOLORY DRZWI

ORZECH ALPEJSKI



BIAŁY



MAHOŃ

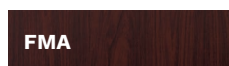

STALOWOSZARY



ORZECH BRAZyliJSKI



ANTRACYT



JASNY ORZECH



CIEMNY ANTRACYT



ZŁOTY DĄB



WINCHESTER





W93 WERONA 3



W6A WERONA 4



W9A WERONA 5

OKUCIA

KLAMKA-KLAMKA



KLAMKA-GAŁKA



KOLORY OKUĆ

ANODA PLATYNA



ANODA SREBRNA



ANODA CZARNA



KOLORY DRZWI

ORZECH ALPEJSKI



MAHOŃ



ORZECH BRAZYLIJSKI



JASNY ORZECH



ZŁOTY DĄB



WINCHESTER



BIAŁY



STALOWOSZARY



ANTRACYT



CIEMNY ANTRACYT



CLASSIC

LIZBONA / WENECJA / LONDYN



W24 LIZBONA



W9N WENECJA

ROZMIAR

80 90N 90E

MODEL

OPTIMA 50

OPTIMA 60

W24 LIZBONA	2 109 Zł	2 445 Zł
W9N WENECJA	2 109 Zł	2 445 Zł
W13 LONDYN	2 109 Zł	2 755 Zł
W5L LONDYN 1	-	2 445 Zł

WYPOSAŻENIE STANDARDOWE RC2

- SKRZYDŁO PRZESZKLONE SPEŁNIAJĄCE WARUNKI PROGRAMU CZYSTE POWIETRZE
- 3 PRZYLGI SZKRYDŁA
- OPTIMA 50 OŚCIEŻNICA STALOWA, OPTIMA 60 OŚCIEŻNICA PERFOTHERM
- ZAWIAS 2D Z OSŁONKAMI W KOLORZE OKUĆ
- WZÓR DWUSTRONNY
- PRÓG ALUMINIOWY
- KOMPLET OKUĆ Z OCHRONĄ WKŁADKI
- SZYLDY DZIELONE BERGEN I BLOK
- WKŁADKI W KLASIE 5, SYSTEM JEDNEGO KLUCZA
- GŁĘBOKIE TŁOCZENIE

DOPLĄTY

OŚCIEŻNICA ALUTHERM OPTIMA (DRZWI OPTIMA 60)	950 ZŁ	OCHRONA GÓRNEGO SZYLDU	30 ZŁ
OŚCIEŻNICA STALOWA PERFOTHERM OPTIMA (DRZWI OPTIMA 50)	120 ZŁ	KLAMKO - GAŁKA	50 ZŁ
DRZWI DWUKOLOROWE	500 ZŁ	KONTAKTRON	120 ZŁ
PAKIET RC3 (OPTIMA 60 WZÓR W24, W9N, W13)	370 ZŁ	ELEKTROZACZEP Z FUNKCJĄ DZIEŃ / NOC	250 ZŁ
WKŁADKI W KLASIE 6 W SYSTEMIE JEDNEGO KLUCZA	180 ZŁ	SKRACANIE DRZWI (10, 20, 30, 40, 60, 80, 100 mm)	215 ZŁ
		ZESTAW TEDEE	1 650 ZŁ

* DOŚWIETLA ALUMINIOWE STAŁE: STRONY 88-89, PEŁNA LISTA WYPOSAŻENIA: STRONY 94-99

SZYBA



MATOWA



REFLEKS BRĄZ



MIRA STAR (SZYBA LUSTRZANA)

KOLORY DRZWI

ORZECH ALPEJSKI

FRR

MAHOŃ

FMA

ORZECH BRAZYLIIJSKI JASNY ORZECH

FRB

FRP

ZŁOTY DĄB

FDE

WINCHESTER

FDW

BIAŁY

FSB

STALOWOSZARY

FKZ

ANTRACYT

FKG

CIEMNY ANTRACYT

FKF



W13 LONDYN



W5L LONDYN 1

OKUCIA

KLAMKA-KLAMKA



KLAMKA-GAŁKA



KOLORY OKUĆ

ANODA PLATYNA



ANODA SREBRNA



ANODA CZARNA



KOLORY DRZWI

ORZECH ALPEJSKI



MAHOŃ

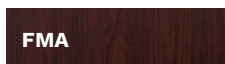

ORZECH BRAZYLIJSKI JASNY ORZECH



ZŁOTY DĄB



WINCHESTER



BIAŁY



STALOWOSZARY



ANTRACYT



CIEMNY ANTRACYT



CLASSIC BARCELONA / GENEWA



W54 BARCELONA



W53 BARCELONA 1

ROZMIAR

80 90N 90E

MODEL

	OPTIMA 50	OPTIMA 60
W54 BARCELONA	2 109 zł	2 455 zł
W53 BARCELONA 1	-	2 755 zł
G76 GENEWA 1	-	2 755 zł
G75 GENEWA 2	-	2 755 zł
D75 GENEWA 3	2 109 zł	2 455 zł

WYPOSAŻENIE STANDARDOWE RC2

- SKRZYDŁO PRZESZKLONE SPEŁNIAJĄCE WARUNKI PROGRAMU CZYSTE POWIETRZE
- 3 PRZYLGI SZKRZYDŁA
- OPTIMA 50 OŚCIEŻNICA STALOWA, OPTIMA 60 OŚCIEŻNICA PERFOTHERM
- ZAWIAS 2D Z OSŁONKAMI W KOLORZE OKUĆ
- WZÓR DWUSTRONNY
- PRÓG ALUMINIOWY
- KOMPLET OKUĆ Z OCHRONĄ WKŁADKI
- SZYLDY DZIELONE BERGEN I BLOK
- WKŁADKI W KLASIE 5, SYSTEM JEDNEGO KLUCZA
- GŁĘBOKIE TŁOCZENIE (BARCELONA)

DOPLĄTY

OŚCIEŻNICA ALUTHERM OPTIMA (DRZWI OPTIMA 60)	950 ZŁ	OCHRONA GÓRNEGO SZYLDU	30 ZŁ
OŚCIEŻNICA STALOWA PERFOTHERM OPTIMA (DRZWI OPTIMA 50)	120 ZŁ	KLAMKO - GAŁKA	50 ZŁ
DRZWI DWUKOLOROWE	500 ZŁ	KONTAKTRON	120 ZŁ
PAKIET RC3 (OPTIMA 60 WZÓR W54, D75)	370 ZŁ	ELEKTROZACZEP Z FUNKCJĄ DZIEŃ / NOC	250 ZŁ
WKŁADKI W KLASIE 6 W SYSTEMIE JEDNEGO KLUCZA	180 ZŁ	SKRACANIE DRZWI (10, 20, 30, 40, 60, 80, 100 mm)	215 ZŁ
		ZESTAW TEDEE	1 650 ZŁ

* DOŚWIETLA ALUMINIOWE STAŁE: STRONY 88-89, PEŁNA LISTA WYPOSAŻENIA: STRONY 94-99

SZYBA



MATOWA



REFLEKS BRĄZ



MIRA STAR (SZYBA LUSTRZANA)

KOLORY DRZWI

ORZECH ALPEJSKI



FRR

MAHOŃ



FMA

ORZECH BRAZYLIIJSKI



FRB

JASNY ORZECH



FRP

ZŁOTY DĄB



FDE

WINCHESTER



FDW

BIAŁY



FSB

STALOWOSZARY



FKZ

ANTRACYT



FKG

CIEMNY ANTRACYT



FKF



G76 GENEWA 1



G75 GENEWA 2



D75 GENEWA 3

OKUCIA

KLAMKA-KLAMKA



KLAMKA-GAŁKA



KOLORY OKUĆ

ANODA PLATYNA



ANODA SREBRNA



ANODA CZARNA



KOLORY DRZWI

ORZECH ALPEJSKI



MAHOŃ



ORZECH BRAZYLIJSKI



JASNY ORZECH



ZŁOTY DĄB



WINCHESTER



BIAŁY



STALOWOSZARY



ANTRACYT



CIEMNY ANTRACYT



DRZWI OPTIMA 60 DUO

GERDA®

Drzwi OPTIMA DUO 60 to propozycja dla osób poszukujących drzwi o niestandardowych wymiarach. Dzięki zastosowaniu tzw. skrzydła biernego można uzyskać większą szerokość przejścia. Skrzydło bierne jest dostępne zarówno bez przeszkleń jak i z przeszkleciem, jednocześnie spełniając funkcję doświetlenia bocznego.

CHARAKTERYSTYKA

- ✓ DRZWI WEJŚCIOWE DO BUDYNKÓW JEDNO I WIELORODZINNYCH
- ✓ SKRZYDŁA STALOWE O GRUBOŚCI 60 mm WYPEŁNIONE EKSPANDOWANYM POLISTYRENEM MODYFIKOWANYM
- ✓ DOSTĘPNE W ZESTAWIE Z OŚCIEŻNICĄ PERFOATHERM ORAZ PROGIEM ALUMINIOWYM
- ✓ OPCJONALNIE ZA DOPŁATĄ OŚCIEŻNICA ALUMINIOWA ALUTHERM OPTIMA
- ✓ SKRZYDŁA BIERNE W WERSJI PEŁNEJ I PRZESZKLONEJ, W ROZMIARACH 30, 40, 50
- ✓ DRZWI DOSTĘPNE W 12 KOLORACH

WYMIARY ZEWNĘTRZNE OŚCIEŻNIC ORAZ OTWORY MONTAŻOWE PODANE NA STRONACH 104-105.

WZORY SKRZYDEŁ BIERNYCH

Cena skrzydła biernego zawiera cenę dostawki oraz dopłatę do progu oraz ościeżnicy. Dopłata do ościeżnicy Alutherm - 1000 zł.

NAZWA	ROZMIAR	CENA
P00	30 40 50	1350 ZŁ
PD4	40	1350 ZŁ
GH1	40 50	1960 ZŁ
GC2	40 50	1960 ZŁ
GN5	30 40 50	2040 ZŁ
GPD	30 40 50	1960 ZŁ
DN3 / DN3B	30 40 50	2040 ZŁ
DN6 / DN6B	30 40 50	2040 ZŁ
DT8 / DT8B	30 40 50	2200 ZŁ
DW9 / DW9B	30 40 50	2180 ZŁ
DW8 / DW8B	30 40 50	2200 ZŁ
DPE / DPEB	30 40 50	1960 ZŁ
PD5	30 40 50	1530 ZŁ
PD5A	30 40 50	1530 ZŁ
PD5B	30 40 50	1530 ZŁ
NMB	30 40 50	1530 ZŁ
NMBA	30 40 50	1530 ZŁ
NMBB	30 40 50	1530 ZŁ
NMA	30 40 50	1530 ZŁ
NMAA	30 40 50	1530 ZŁ
NMAB	30 40 50	1530 ZŁ

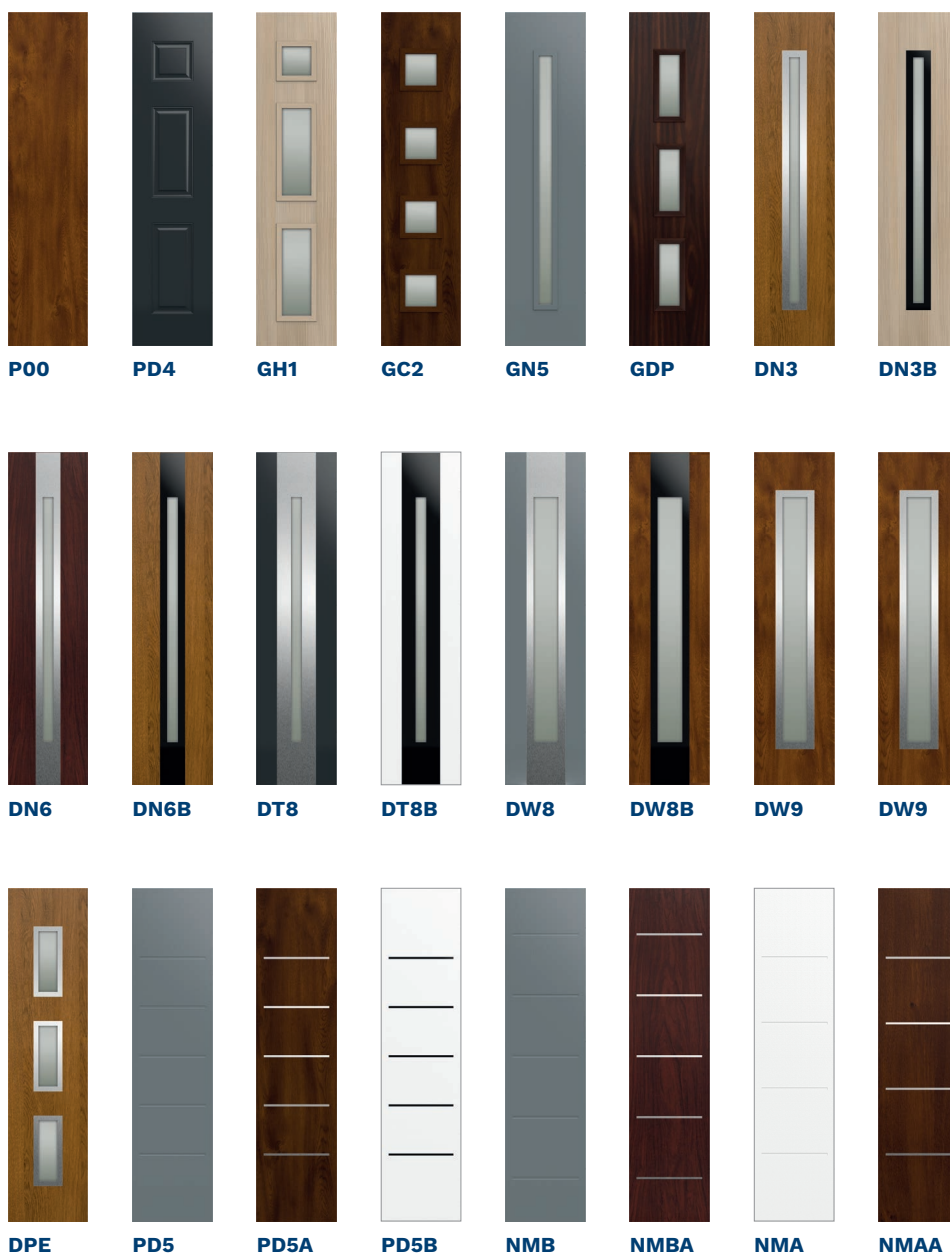



SOJ BERGAMO2 + NMBA



NS5 HANOVER 5 + DW9



ST8 RYGA + P00



TMMA TOKIO 2A + P00



NS9 MILANO 12 + DW8



SNUA MILANO 4A + PD5A



NT2B TURYN 2B + DT8



ST4A UPPSALA 1A + NMAA



NS6 HANOVER 6 + DW8

DOŚWIETLA ALUMINIOWE

GERDA®



ZESTAW GL



ZESTAW G



ZESTAW GP



ZESTAW L

DOŚWIETLA ALUMINIOWE DO DRZWI THERMO PRIME 75

Aby uzyskać kompletną cenę drzwi z doświetleniem należy dodać:

- cenę drzwi
- cenę doświetla

OŚCIEŻNICA ALUTHERM PRIME

ROZMIAR	WYSOKOŚĆ Hz	SZEROKOŚĆ Sc
80	standard 2087 mm	918 mm
90N	niestandardowe: 2150 mm 2200 mm 2250 mm	988 mm
90E		1031 mm
100E		1131 mm
	2300 mm	
	2350 mm	
	2400 mm	

DOŚWIETLA BOCZNE

WYSOKOŚĆ Hz	RODZAJ DOŚWIETLA / SZYBY	SZEROKOŚĆ Ld/Pd						
		do 300 mm	do 400 mm	do 500 mm	do 600 mm	do 700 mm	do 800 mm	do 900 mm
2087 mm	DOŚWIETLA Z SZYBĄ BEZPIECZNĄ	1 850 ZŁ	2 020 ZŁ	2 240 ZŁ	2 440 ZŁ	2 690 ZŁ	2 940 ZŁ	3 190 ZŁ
	DOSWIETLA ANTYWŁAMANIOWE RC2 Z SZYBĄ P4	2 000 ZŁ	2 170 ZŁ	2 390 ZŁ	2 590 ZŁ	2 840 ZŁ	3 090 ZŁ	3 340 ZŁ
do 2200 mm	DOŚWIETLA Z SZYBĄ BEZPIECZNĄ	1 950 ZŁ	2 120 ZŁ	2 340 ZŁ	2 540 ZŁ	2 790 ZŁ	3 040 ZŁ	3 290 ZŁ
	DOSWIETLA ANTYWŁAMANIOWE RC2 Z SZYBĄ P4	2 100 ZŁ	2 270 ZŁ	2 490 ZŁ	2 690 ZŁ	2 940 ZŁ	3 190 ZŁ	3 440 ZŁ
do 2300 mm	DOŚWIETLA Z SZYBĄ BEZPIECZNĄ	2 000 ZŁ	2 170 ZŁ	2 390 ZŁ	2 590 ZŁ	2 840 ZŁ	3 090 ZŁ	3 340 ZŁ
	DOSWIETLA ANTYWŁAMANIOWE RC2 Z SZYBĄ P4	2 150 ZŁ	2 320 ZŁ	2 540 ZŁ	2 740 ZŁ	2 990 ZŁ	3 240 ZŁ	3 490 ZŁ
do 2400 mm	DOŚWIETLA Z SZYBĄ BEZPIECZNĄ	2 050 ZŁ	2 220 ZŁ	2 440 ZŁ	2 640 ZŁ	2 890 ZŁ	3 140 ZŁ	3 390 ZŁ
	DOSWIETLA ANTYWŁAMANIOWE RC2 Z SZYBĄ P4	2 200 ZŁ	2 370 ZŁ	2 590 ZŁ	2 790 ZŁ	3 040 ZŁ	3 290 ZŁ	3 540 ZŁ

* DOŚWIETLA BOCZNE SZEROKOŚĆ STANDARD W PODZIAŁCE CO 50 mm. W PODZIAŁCE CO 10 mm DOPLATA 25%.

DOŚWIETLA GÓRNE

WYSOKOŚĆ Hd	RODZAJ DOŚWIETLA / SZYBY	SZEROKOŚĆ Ld/B/Pd				
		do 1150 mm	do 1550 mm	do 1950 mm	do 2350 mm	do 2950 mm
300 mm	DOŚWIETLA Z SZYBĄ BEZPIECZNĄ	1 140 ZŁ	1 340 ZŁ	1 540 ZŁ	1 740 ZŁ	1 940 ZŁ
400 mm		1 190 ZŁ	1 390 ZŁ	1 590 ZŁ	1 790 ZŁ	1 990 ZŁ
500 mm		1 240 ZŁ	1 440 ZŁ	1 640 ZŁ	1 840 ZŁ	2 040 ZŁ
300 mm	DOSWIETLA ANTYWŁAMANIOWE RC2 Z SZYBĄ P4	1 440 ZŁ	1 840 ZŁ	2 240 ZŁ	2 640 ZŁ	3 040 ZŁ
400 mm		1 490 ZŁ	1 890 ZŁ	2 290 ZŁ	2 690 ZŁ	3 090 ZŁ
500 mm		1 540 ZŁ	1 940 ZŁ	2 340 ZŁ	2 740 ZŁ	3 140 ZŁ

* DOŚWIETLA GÓRNE WYSOKOŚĆ STANDARD W PODZIAŁCE CO 50 mm. W PODZIAŁCE CO 10 mm DOPLATA 25%.



ZESTAW P



ZESTAW LP



ZESTAW LGP

DOŚWIETLA ALUMINIOWE DO DRZWI THERMO PREMIUM 75, THERMO PREMIUM 60 I OPTIMA 60

Aby uzyskać kompletną cenę drzwi z doświetleniem należy dodać:

- cenę drzwi
- dopłatę ościeżnicy ALUTHERM
- cenę doświetla

OŚCIEŻNICA ALUTHERM PREMIUM, OPTIMA

ROZMIAR	WYSOKOŚĆ Hz	SZEROKOŚĆ Sc
80N	2087 mm	888 mm
80		918 mm
90N		988 mm
90E		1031 mm
100E		1131 mm

DOŚWIETLA BOCZNE

WYSOKOŚĆ Hz	RODZAJ DOŚWIETLA / SZYBY	SZEROKOŚĆ Ld/Pd						
		do 300 mm	do 400 mm	do 500 mm	do 600 mm	do 700 mm	do 800 mm	do 900 mm
2087 mm	DOŚWIETLA Z SZYBĄ BEZPIECZNA	1 750 ZŁ	1 920 ZŁ	2 140 ZŁ	2 340 ZŁ	2 590 ZŁ	2 840 ZŁ	3 090 ZŁ
	DOSWIETLA ANTYWŁAMANIOWE RC2 Z SZYBĄ P4	1 900 ZŁ	2 070 ZŁ	2 290 ZŁ	2 490 ZŁ	2 740 ZŁ	2 990 ZŁ	3 240 ZŁ

* DOŚWIETLA BOCZNE SZEROKOŚĆ STANDARD W PODZIAŁCE CO 50 mm. W PODZIAŁCE CO 10 mm DOPLATA 25%.

DOŚWIETLA GÓRNE

WYSOKOŚĆ Hc	WYSOKOŚĆ Hd	RODZAJ DOŚWIETLA / SZYBY	SZEROKOŚĆ Ld/B/Pd				
			do 1150 mm	do 1550 mm	do 1950 mm	do 2350 mm	do 2950 mm
2387 mm - 2587 mm	300 mm	DOŚWIETLA Z SZYBĄ BEZPIECZNA	1 040 ZŁ	1 240 ZŁ	1 440 ZŁ	1 640 ZŁ	1 840 ZŁ
	400 mm		1 090 ZŁ	1 290 ZŁ	1 490 ZŁ	1 690 ZŁ	1 890 ZŁ
	500 mm		1 140 ZŁ	1 340 ZŁ	1 540 ZŁ	1 740 ZŁ	1 940 ZŁ
2387 mm - 2587 mm	300 mm	DOSWIETLA ANTYWŁAMANIOWE RC2 Z SZYBĄ P4	1 340 ZŁ	1 740 ZŁ	2 140 ZŁ	2 540 ZŁ	2 940 ZŁ
	400 mm		1 390 ZŁ	1 790 ZŁ	2 190 ZŁ	2 590 ZŁ	2 990 ZŁ
	500 mm		1 440 ZŁ	1 840 ZŁ	2 240 ZŁ	2 640 ZŁ	3 040 ZŁ

* DOŚWIETLA GÓRNE WYSOKOŚĆ STANDARD W PODZIAŁCE CO 50 mm. W PODZIAŁCE CO 10 mm DOPLATA 25%.

WYBIERZ KOLOR SWOICH DRZWI

ORZECH ALPEJSKI

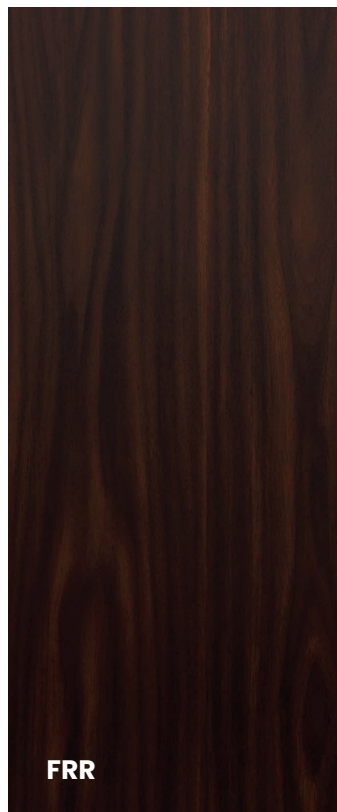

FRR

MAHOŃ

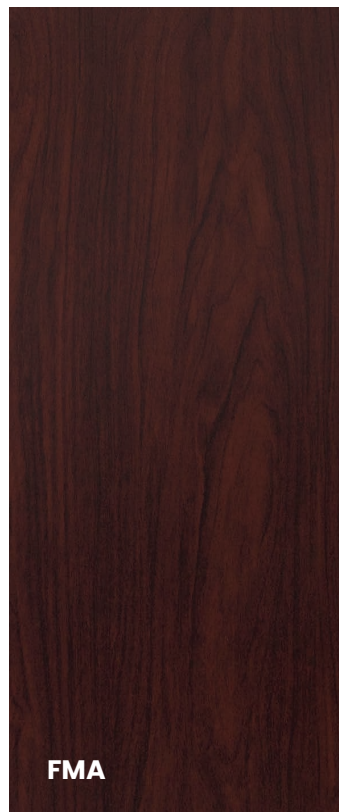

FMA

ORZECH BRAZYLIJSKI

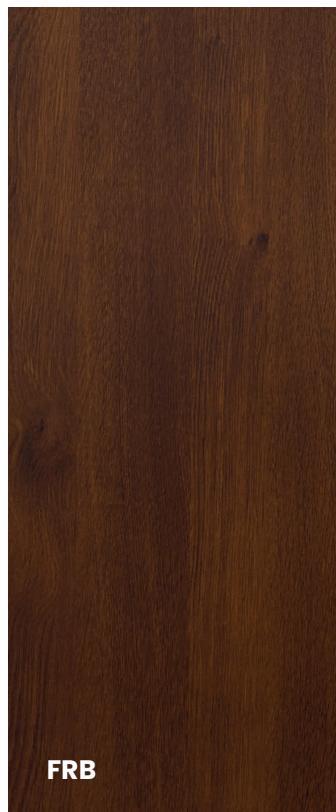

FRB

JASNY ORZECH



FRP

BIAŁY

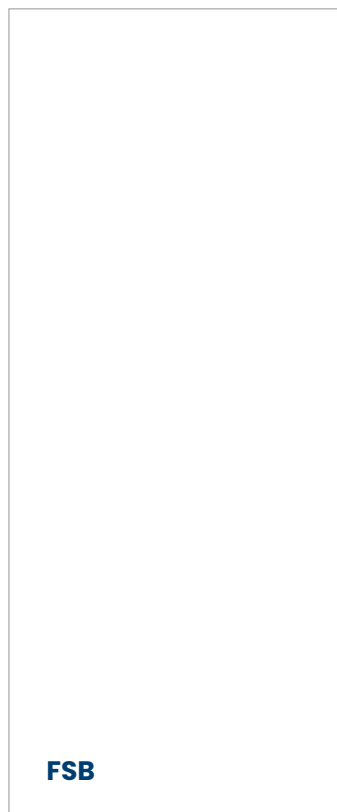

FSB

STALOWOSZARY

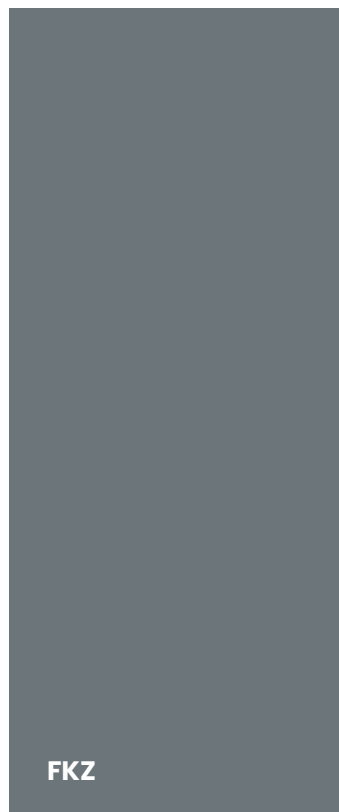

FKZ

ANTRACYT

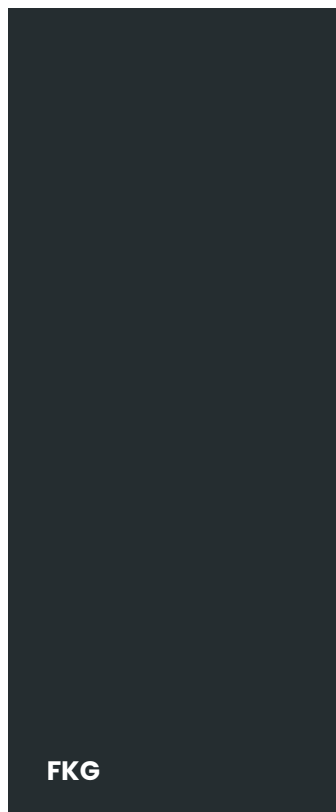

FKG

CIEMNY ANTRACYT



FKF

ZŁOTY DĄB



WINCHESTER



DĄB TURNER



JASNY WENGE



CZARNY



ZESTAW OSPRZĘTU

GERDA®

THERMO PRIME / THERMO PREMIUM (PRZYKŁADOWE KONFIGURACJE)

**TW300 BERGEN
(KLAMKI ALEX) THERMO
PRIME**



**SZYLD PIERŚCIENIOWY
(KLAMKA JEDNOSTRONNNA
ALEX), POCHWYT**

AMSTERDAM MONTREAL



**TD200 BERGEN
(KLAMKI BETA)**



**TD200 BERGEN
(GAŁKO - KLAMKA ALEX)**

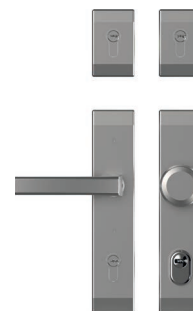

KOLORY SZYLDÓW

ANODA PLATYNA



ANODA SREBRNA



ANODA CZARNA



ZESTAW OSPRZĘTU STANDARDOWEGO THERMO PRIME / PREMIUM

350 ZŁ

WKŁADKA KLASA 5 THERMO PRIME / WKŁADKI KLASA 5 W SYSTEMIE JEDNEGO KLUCZA THERMO PREMIUM

5 KLUCZY + MONTAŻOWE

SZYLD ZAMKA GŁÓWNEGO Z OCHRONĄ*

SZYLD ZAMKA DODATKOWEGO BEZ OCHRONY (THERMO PREMIUM)

NASADKI NA ZAWIASY W KOLORZE SZYLDÓW

DOPLATY

CENA

SZYLD ZAMKA DODATKOWEGO Z OCHRONĄ (THERMO PREMIUM)

+30 ZŁ

ZESTAW GAŁKO - KLAMKA

+50 ZŁ

WKADKI W KLASIE 6 W SYSTEMIE JEDNEGO KLUCZA

+180 ZŁ

WKŁADKA ZAMKA GŁÓWNEGO W KLASIE 5 / DODATKOWEGO W KLASIE 2 (THERMO PREMIUM)

-50 ZŁ

DOSTOSOWANIE DO POCHWYTU Z PRZYCISKIEM

+240 ZŁ

POCHWYT AMSTERDAM / MONTREAL 1800 mm, ZALECANY ELEKTROZACZEP

+825 ZŁ

POCHWYT AMSTERDAM / MONTREAL 1700 mm, ZALECANY ELEKTROZACZEP

+800 ZŁ

POCHWYT AMSTERDAM / MONTREAL 1500 mm, ZALECANY ELEKTROZACZEP

+770 ZŁ

POCHWYT AMSTERDAM / MONTREAL 1000 mm, ZALECANY ELEKTROZACZEP

+715 ZŁ

POCHWYT Z PRZYCISKIEM AMSTERDAM / MONTREAL 1800 mm Z DOSTOSOWANIEM SKRZYDŁA ORAZ ELEKTROZACZEPEM

+1640 ZŁ

POCHWYT Z PRZYCISKIEM AMSTERDAM / MONTREAL 1700 mm Z DOSTOSOWANIEM SKRZYDŁA ORAZ ELEKTROZACZEPEM

+1620 ZŁ

POCHWYT Z PRZYCISKIEM AMSTERDAM / MONTREAL 1500 mm Z DOSTOSOWANIEM SKRZYDŁA ORAZ ELEKTROZACZEPEM

+1590 ZŁ

POCHWYT Z PRZYCISKIEM AMSTERDAM / MONTREAL 1000 mm Z DOSTOSOWANIEM SKRZYDŁA ORAZ ELEKTROZACZEPEM

+1540 ZŁ

ZESTAW TEDEE

+1650 ZŁ

*DLA DRZWI Z POCHWYTEM PIERŚCIEŃ OZDOBNY

OPTIMA (PRZYKŁADOWE KONFIGURACJE)

TW200 BLOK (KLAMKI BETA)

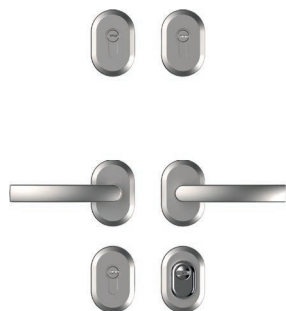

TW200 BLOK (GAŁKO-KLAMKA BETA)

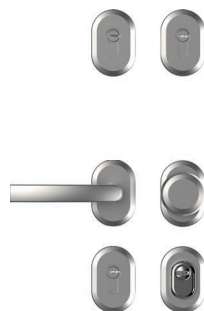

TW300 BERGEN (KLAMKO - KLAMKA ALEX)



TW200 BLOK (KLAMKA JEDNOSTRONNA BETA), POCHWYT

AMSTERDAM MONTREAL

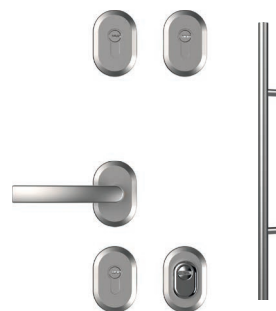

KOLORY SZYLDÓW

ANODA PLATYNA



ANODA SREBRNA



ANODA CZARNA



ZESTAW OSPRZĘTU STANDARDOWEGO OPTIMA

350 ZŁ

WKŁADKI KLASA 5 W SYSTEMIE JEDNEGO KLUCZA

5 KLUCZY + MONTAŻOWE

SZYLD ZAMKA GŁÓWNEGO Z OCHRONĄ

SZYLD ZAMKA DODATKOWEGO BEZ OCHRONY

NASADKI NA ZAWIASY W KOLORZE SZYLDÓW

DOPLATY

CENA

SZYLD ZAMKA DODATKOWEGO Z OCHRONĄ

+30 ZŁ

ZESTAW GAŁKO - KLAMKA

+50 ZŁ

WKŁADKA W KLASIE 6, W SYSTEMIE JEDNEGO KLUCZA

+180 ZŁ

WKŁADKA ZAMKA GŁÓWNEGO W KLASIE 2 / DODATKOWEGO W KLASIE 2, SZYLDY NIECHRONIONE (BRAK KLASY RC2 DLA DRZWI)

-100 ZŁ

DOSTOSOWANIE DO POCHWYTU Z PRZYCISKIEM

+240 ZŁ

POCHWYT AMSTERDAM / MONTREAL 1800 mm, ZALECANY ELEKTROZACZEP

+825 ZŁ

POCHWYT AMSTERDAM / MONTREAL 1700 mm, ZALECANY ELEKTROZACZEP

+800 ZŁ

POCHWYT AMSTERDAM / MONTREAL 1500 mm, ZALECANY ELEKTROZACZEP

+770 ZŁ

POCHWYT AMSTERDAM / MONTREAL 1000 mm, ZALECANY ELEKTROZACZEP

+715 ZŁ

POCHWYT Z PRZYCISKIEM AMSTERDAM / MONTREAL 1800 mm Z DOSTOSOWANIEM SKRZYDŁA ORAZ ELEKTROZACZEPEM

+1640 ZŁ

POCHWYT Z PRZYCISKIEM AMSTERDAM / MONTREAL 1700 mm Z DOSTOSOWANIEM SKRZYDŁA ORAZ ELEKTROZACZEPEM

+1620 ZŁ

POCHWYT Z PRZYCISKIEM AMSTERDAM / MONTREAL 1500 mm Z DOSTOSOWANIEM SKRZYDŁA ORAZ ELEKTROZACZEPEM

+1590 ZŁ

POCHWYT Z PRZYCISKIEM AMSTERDAM / MONTREAL 1000 mm Z DOSTOSOWANIEM SKRZYDŁA ORAZ ELEKTROZACZEPEM

+1540 ZŁ

ZESTAW TEDEE

+1650 ZŁ

WYPOSAŻENIE OPCJONALNE

GERDA®

DOPLĄTY DO DRZWI

	OPTIMA 50	OPTIMA 60	THERMO PREMIUM 60	THERMO PREMIUM 75	THERMO PRIME 75
ELEKTROZACZEP Z FUNKCJĄ DZIEŃ/NOC MONTOWANY FABRYCZNIE W OŚCIEŻNICY (DOPLĄTA DO CENY DRZWI); ZALECANE DO DRZWI Z POCHWYTEM; ZALECANE ZASTOSOWANIE ZASILACZA – AKCESORIA DODATKOWE S. 97	250 ZŁ	250 ZŁ	250 ZŁ	250 ZŁ	250 ZŁ
ELEKTROZACZEP Z FUNKCJĄ DZIEŃ/NOC MONTOWANY W DOSTAWCE DUO; ZALECANE DO DRZWI Z POCHWYTAMI	-	520 ZŁ	-	-	-
KONTAKTRON MONTOWANY FABRYCZNIE W OŚCIEŻNICY	120 ZŁ	120 ZŁ	120 ZŁ	120 ZŁ	120 ZŁ
SKRÓCENIE DRZWI W ZAKESIE 0 – 100 mm (DLA WYBRANYCH WZORÓW)	215 ZŁ	215 ZŁ	215 ZŁ	215 ZŁ	215 ZŁ
DRZWI WYŻSZE – WYSOKOŚĆ CAŁKOWITA DO 2400 mm	-	-	-	-	
					2150 mm = 330 ZŁ; 2200 mm = 330 ZŁ; 2250 mm = 680 ZŁ; 2300 mm = 680 ZŁ; 2350 mm = 1100 ZŁ; 2400 mm = 1100 ZŁ
SKRZYDŁO DRZWI DWUKOLOROWE	500 ZŁ	500 ZŁ	500 ZŁ	500 ZŁ	500 ZŁ
WEWNĘTRZNE WZMOCNIENIE SKRZYDŁA POD SAMOZAMYKACZ NAWIERZCHNIOWY (DOPLĄTA DO CENY DRZWI)	100 ZŁ	100 ZŁ	100 ZŁ	100 ZŁ	100 ZŁ
SAMOZAMYKACZ UKRYTY	-	-	1100 ZŁ	1100 ZŁ	-
OKAPNIK (ZALECANY DO DRZWI OTWIERANYCH DO WEWNĄTRZ)	70 ZŁ	70 ZŁ	70 ZŁ	70 ZŁ	70 ZŁ
DOSTOSOWANIE DO POCHWYTU Z PRZYCISKIEM	-	240 ZŁ	240 ZŁ	240 ZŁ	240 ZŁ

KLAMKI I SZYLDY

OPTIMA 50 OPTIMA 60 THERMO PREMIUM 60 THERMO PREMIUM 75 THERMO PRIME 75

	BERGEN – KLAMKI NA SZYLDZIE DŁUGIM TD200 DWUSTRONNA	-	-	230 ZŁ	230 ZŁ	-
	BERGEN – KLAMKI NA SZYLDZIE DŁUGIM TD1000 DWUSTRONNA	-	-	250 ZŁ	250 ZŁ	-
	BERGEN – KLAMKA NA SZYLDZIE DŁUGIM JEDNOSTRONNA	-	-	210 ZŁ	210 ZŁ	-
	BERGEN – KLAMKO GAŁKA NA SZYLDZIE DŁUGIM TD200	-	-	280 ZŁ	280 ZŁ	-
	BERGEN – KLAMKO GAŁKA NA SZYLDZIE DŁUGIM TD1000	-	-	300 ZŁ	300 ZŁ	-
	BERGEN – KLAMKI NA SZYLDZIE DZIELONYM DWUSTRONNA	140 ZŁ	140 ZŁ	-	-	140 ZŁ
	BERGEN – KLAMKA NA SZYLDZIE DZIELONYM JEDNOSTRONNA	120 ZŁ	120 ZŁ	-	-	120 ZŁ
	BERGEN – KLAMKO GAŁKA NA SZYLDZIE DZIELONYM	190 ZŁ	190 ZŁ	-	-	190 ZŁ
	BERGEN – SZYLD DZIELONY Z OCHRONĄ WKŁADKI TW300	85 ZŁ	85 ZŁ	85 ZŁ	85 ZŁ	85 ZŁ
	BERGEN – SZYLD DZIELONY BEZ OCHRONY WKŁADKI	55 ZŁ	55 ZŁ	55 ZŁ	55 ZŁ	55 ZŁ















WYPOSAŻENIE OPCJONALNE

GERDA®

















KLAMKI I SZYLDY

		OPTIMA 50	OPTIMA 60	THERMO PREMIUM 60	THERMO PREMIUM 75	THERMO PRIME 75
	BLOK – KLAMKI NA SZYLDZIE DZIELONYM DWUSTRONNA	140 ZŁ	140 ZŁ	-	-	-
	BLOK – KLAMKA NA SZYLDZIE DZIELONYM JEDNOSTRONNA	120 ZŁ	120 ZŁ	-	-	-
	BLOK – KLAMKO GAŁKA NA SZYLDZIE DZIELONYM	190 ZŁ	190 ZŁ	-	-	-
	BLOK – SZYLD DZIELONY Z OCHRONĄ WKŁADKI TW200	85 ZŁ	85 ZŁ	-	-	-
	BLOK – SZYLD DZIELONY Z OCHRONĄ WKŁADKI TW1000	110 ZŁ	110 ZŁ	-	-	-
	BLOK – SZYLD DZIELONY BEZ OCHRONY WKŁADKI	55 ZŁ	55 ZŁ	-	-	-

POCHWYTY

		OPTIMA 50	OPTIMA 60	THERMO PREMIUM 60	THERMO PREMIUM 75	THERMO PRIME 75
	AMSTERDAM POCHWYT PROSTOKĄTNY 1800 (PRZEKRÓJ 40 × 20 mm)	825 ZŁ	825 ZŁ	825 ZŁ	825 ZŁ	825 ZŁ
	AMSTERDAM POCHWYT PROSTOKĄTNY 1700 (PRZEKRÓJ 40 × 20 mm)	800 ZŁ	800 ZŁ	800 ZŁ	800 ZŁ	800 ZŁ
	AMSTERDAM POCHWYT PROSTOKĄTNY 1500 (PRZEKRÓJ 40 × 20 mm)	770 ZŁ	770 ZŁ	770 ZŁ	770 ZŁ	770 ZŁ
	AMSTERDAM POCHWYT PROSTOKĄTNY 1000 (PRZEKRÓJ 40 × 20 mm)	715 ZŁ	715 ZŁ	715 ZŁ	715 ZŁ	715 ZŁ
	AMSTERDAM POCHWYT Z PRZYCISKIEM PROSTOKĄTNY 1800 (PRZEKRÓJ 40 × 20 mm), NIEZBĘDNY ZAKUP ELEKTROZACZĘPU	1 150 ZŁ	1 150 ZŁ	1 150 ZŁ	1 150 ZŁ	1 150 ZŁ
	AMSTERDAM POCHWYT Z PRZYCISKIEM PROSTOKĄTNY 1700 (PRZEKRÓJ 40 × 20 mm), NIEZBĘDNY ZAKUP ELEKTROZACZĘPU	1 130 ZŁ	1 130 ZŁ	1 130 ZŁ	1 130 ZŁ	1 130 ZŁ
	AMSTERDAM POCHWYT Z PRZYCISKIEM PROSTOKĄTNY 1500 (PRZEKRÓJ 40 × 20 mm), NIEZBĘDNY ZAKUP ELEKTROZACZĘPU	1 100 ZŁ	1 100 ZŁ	1 100 ZŁ	1 100 ZŁ	1 100 ZŁ
	AMSTERDAM POCHWYT Z PRZYCISKIEM PROSTOKĄTNY 1000 (PRZEKRÓJ 40 × 20 mm), NIEZBĘDNY ZAKUP ELEKTROZACZĘPU	1 050 ZŁ	1 050 ZŁ	1 050 ZŁ	1 050 ZŁ	1 050 ZŁ
	MONTREAL POCHWYT OKRĄGŁY 1800 (PRZEKRÓJ Ø 35 mm)	825 ZŁ	825 ZŁ	825 ZŁ	825 ZŁ	825 ZŁ
	MONTREAL POCHWYT OKRĄGŁY 1700 (PRZEKRÓJ Ø 35 mm)	800 ZŁ	800 ZŁ	800 ZŁ	800 ZŁ	800 ZŁ
	MONTREAL POCHWYT OKRĄGŁY 1500 (PRZEKRÓJ Ø 35 mm)	770 ZŁ	770 ZŁ	770 ZŁ	770 ZŁ	770 ZŁ
	MONTREAL POCHWYT OKRĄGŁY 1000 (PRZEKRÓJ Ø 35 mm)	715 ZŁ	715 ZŁ	715 ZŁ	715 ZŁ	715 ZŁ
	MONTREAL POCHWYT Z PRZYCISKIEM OKRĄGŁY 1800 (PRZEKRÓJ Ø 35 mm), NIEZBĘDNY ZAKUP ELEKTROZACZĘPU	1 150 ZŁ	1 150 ZŁ	1 150 ZŁ	1 150 ZŁ	1 150 ZŁ
	MONTREAL POCHWYT Z PRZYCISKIEM OKRĄGŁY 1700 (PRZEKRÓJ Ø 35 mm), NIEZBĘDNY ZAKUP ELEKTROZACZĘPU	1 130 ZŁ	1 130 ZŁ	1 130 ZŁ	1 130 ZŁ	1 130 ZŁ
	MONTREAL POCHWYT Z PRZYCISKIEM OKRĄGŁY 1500 (PRZEKRÓJ Ø 35 mm), NIEZBĘDNY ZAKUP ELEKTROZACZĘPU	1 100 ZŁ	1 100 ZŁ	1 100 ZŁ	1 100 ZŁ	1 100 ZŁ
	MONTREAL POCHWYT Z PRZYCISKIEM OKRĄGŁY 1000 (PRZEKRÓJ Ø 35 mm), NIEZBĘDNY ZAKUP ELEKTROZACZĘPU	1 050 ZŁ	1 050 ZŁ	1 050 ZŁ	1 050 ZŁ	1 050 ZŁ

AKCESORIA

		OPTIMA 50	OPTIMA 60	THERMO PREMIUM 60	THERMO PREMIUM 75	THERMO PRIME 75
	WIZJER SZEROKOKĄTNY 50/80	25 ZŁ	25 ZŁ	25 ZŁ	25 ZŁ	25 ZŁ
	WIZJER ELEKTRONICZNY 4,3"	400 ZŁ	400 ZŁ	400 ZŁ	400 ZŁ	400 ZŁ
	WIZJER ELEKTRONICZNY 2,4 "	165 ZŁ	165 ZŁ	165 ZŁ	165 ZŁ	165 ZŁ
	NUMERYCZNA KLAWIATURA KONTROLI DOSTĘPU	430 ZŁ	430 ZŁ	430 ZŁ	430 ZŁ	430 ZŁ
	ZASILACZ BUFOROWY AWZG2-12V; ZALECANY DO DRZWI WYPOSAŻONYCH W ELEKTROZACZEP	430 ZŁ	430 ZŁ	430 ZŁ	430 ZŁ	430 ZŁ
	ZASILACZ IMPULSOWY PSC12015; ZALECANY DO DRZWI WYPOSAŻONYCH W ELEKTROZACZEP	115 ZŁ	115 ZŁ	115 ZŁ	115 ZŁ	115 ZŁ
	LISTWA DOLNA ZAMYKAJĄCA	50 ZŁ	50 ZŁ	-	-	-
	SAMOZAMYKACZ UKRYTY	-	-	1100 ZŁ	1100 ZŁ	-
	SAMOZAMYKACZ GT 1500 STANDARD	250 ZŁ	250 ZŁ	250 ZŁ	250 ZŁ	250 ZŁ
	SAMOZAMYKACZ GT 1500 BLOKADA	340 ZŁ	340 ZŁ	340 ZŁ	340 ZŁ	340 ZŁ
	NASADKI ALUMINIOWE OZDOBNE NA ZAWIASY	50 ZŁ	50 ZŁ	50 ZŁ	50 ZŁ	50 ZŁ
	PRÓG ALUMINIOWY DO OPTIMA 20 mm	125 ZŁ	125 ZŁ	-	-	-
	CIEPŁY PRÓG ALUMINIOWY DO THERMO PRIME, THERMO PREMIUM 20 mm	-	-	135 ZŁ	135 ZŁ	135 ZŁ
	CIEPŁY PRÓG PCV DO THERMO PREMIUM 20 mm	-	-	135 ZŁ	135 ZŁ	135 ZŁ
	PRÓG DREWNIANY 19 mm	125 ZŁ	125 ZŁ	-	-	-
	OKAPNIK W KOLORZE SKRZYDŁA	70 ZŁ	70 ZŁ	70 ZŁ	70 ZŁ	70 ZŁ

WYPOSAŻENIE OPCJONALNE

GERDA®

AKCESORIA

		OPTIMA 50	OPTIMA 60	THERMO PREMIUM 60	THERMO PREMIUM 75	THERMO PRIME 75
	POSZERZENIE BOCZNE STALOWO DREWNIANE 30 mm (DLA OŚCIEŻNIC PERFOTHERM, DUOTHERM)	250 ZŁ	250 ZŁ	250 ZŁ	250 ZŁ	-
	POSZERZENIE BOCZNE STALOWO DREWNIANE 60 mm (DLA OŚCIEŻNIC PERFOTHERM, DUOTHERM)	300 ZŁ	300 ZŁ	300 ZŁ	300 ZŁ	-
	POSZERZENIE BOCZNE ALUMINIOWE 28 mm (DLA OŚCIEŻNICY ALUTHERM ORAZ DOŚWIETLA ALUMINIOWEGO)	-	420 ZŁ	420 ZŁ	420 ZŁ	-
	POSZERZENIE BOCZNE ALUMINIOWE 52 mm (DLA OŚCIEŻNICY ALUTHERM ORAZ DOŚWIETLA ALUMINIOWEGO)	-	540 ZŁ	540 ZŁ	540 ZŁ	-
	POSZERZENIE BOCZNE ALUMINIOWE 114 mm (DLA OŚCIEŻNICY ALUTHERM ORAZ DOŚWIETLA ALUMINIOWEGO)	-	850 ZŁ	850 ZŁ	850 ZŁ	-
	POSZERZENIE BOCZNE ALUMINIOWE 25 mm (DLA OŚCIEŻNICY ALUTHERM PRIME)	-	-	-	-	410 ZŁ
	POSZERZENIE BOCZNE ALUMINIOWE 33 mm (DLA OŚCIEŻNICY ALUTHERM PRIME)	-	-	-	-	440 ZŁ
	POSZERZENIE BOCZNE ALUMINIOWE 44 mm (DLA OŚCIEŻNICY ALUTHERM PRIME)	-	-	-	-	500 ZŁ
	POSZERZENIE BOCZNE ALUMINIOWE 55 mm (DLA OŚCIEŻNICY ALUTHERM PRIME)	-	-	-	-	550 ZŁ
	POSZERZENIE BOCZNE ALUMINIOWE 108 mm (DLA OŚCIEŻNICY ALUTHERM PRIME)	-	-	-	-	825 ZŁ
	POSZERZENIE PODPROGOWE 30 mm	50 ZŁ	50 ZŁ	50 ZŁ	50 ZŁ	50 ZŁ
	PODWALINY (POSZERZENIA) PODPROGOWE Z UTWARDZONEGO POLISTYRENU EKSPANDOWANEGO. (THERMO PRIME)	-	-	-	-	
		70 mm = 150 ZŁ, 100 mm = 195 ZŁ, 130 mm = 240 ZŁ, 160 mm = 280 ZŁ, 190 mm = 330 ZŁ, 220 mm = 375 ZŁ, 250 mm = 420 ZŁ				
	PREPARAT DO KONSERWACJI DRZWI	39 ZŁ	39 ZŁ	39 ZŁ	39 ZŁ	39 ZŁ
	PREPARAT DO KONSERWACJI ZAMKÓW I WKŁADEK 25 ML	10 ZŁ	10 ZŁ	10 ZŁ	10 ZŁ	10 ZŁ
	PREPARAT DO KONSERWACJI ZAMKÓW I WKŁADEK 100 ML	20 ZŁ	20 ZŁ	20 ZŁ	20 ZŁ	20 ZŁ
	PREPARAT DO KONSERWACJI ZAMKÓW I WKŁADEK 400 ML	30 ZŁ	30 ZŁ	30 ZŁ	30 ZŁ	30 ZŁ
	KOMPLET PREPARATÓW DO CZYSZCZENIA STALI NIERDZEWNEJ GERDA INOX-1, INOX-2	35 ZŁ	35 ZŁ	35 ZŁ	35 ZŁ	35 ZŁ
	TAŚMY GERDA RESIST ULTRA DUO DO CIEPŁEGO MONTAŻU	225 ZŁ	225 ZŁ	225 ZŁ	225 ZŁ	225 ZŁ

OPTIMA 50 RC2

ROZMIAR	ZAMEK GŁÓWNY	ZAMEK DODATKOWY	LICZBA KLUCZY	KLASA WKŁADKI	CENA
30/45	ZABIERAK	-	3	2	37,40 ZŁ
30/45	-	ZABIERAK / GAŁKA	3	2	46,80 ZŁ
30/45 ; 45/30	ZABIERAK	ZABIERAK / GAŁKA	5+MONTAŻOWE	5	185 ZŁ
30/45 ; 45/30	ZABIERAK	ZABIERAK / GAŁKA	5+MONTAŻOWE	6	365 ZŁ

OPTIMA 60 RC2/RC3*

ROZMIAR	ZAMEK GŁÓWNY	ZAMEK DODATKOWY	LICZBA KLUCZY	KLASA WKŁADKI	CENA
35/50	ZABIERAK	-	3	2	43,10 ZŁ
35/50 ; 50/35	-	ZABIERAK	3	2	52,40 ZŁ
35/50 ; 50/35	ZABIERAK / ZĘBATKA*	ZABIERAK	5+MONTAŻOWE	5	205 ZŁ
35/50 ; 50/35	ZABIERAK / ZĘBATKA*	ZABIERAK	5+MONTAŻOWE	6	385 ZŁ

THERMO PREMIUM 60 RC2/RC3*

ROZMIAR	ZAMEK GŁÓWNY	ZAMEK DODATKOWY	LICZBA KLUCZY	KLASA WKŁADKI	CENA
35/50	ZABIERAK	-	5+MONTAŻOWE	5	105 ZŁ
35/50 ; 50/35	-	ZABIERAK / GAŁKA	3	2	52,40 ZŁ
35/50 ; 50/35	ZABIERAK / ZĘBATKA*	ZABIERAK / GAŁKA	5+MONTAŻOWE	5	205 ZŁ
35/50 ; 50/35	ZABIERAK / ZĘBATKA*	ZABIERAK / GAŁKA	5+MONTAŻOWE	6	385 ZŁ

THERMO PREMIUM 75 RC2/RC3

ROZMIAR	ZAMEK GŁÓWNY	ZAMEK DODATKOWY	LICZBA KLUCZY	KLASA WKŁADKI	CENA
45/55	ZĘBATKA	-	5+MONTAŻOWE	5	145 ZŁ
45/55 ; 55/45	-	ZABIERAK / GAŁKA	3	2	60,80 ZŁ
45/55 ; 55/45	ZĘBATKA	ZABIERAK / GAŁKA	5+MONTAŻOWE	5	235 ZŁ
45/55 ; 55/45	ZĘBATKA	ZABIERAK / GAŁKA	5+MONTAŻOWE	6	415 ZŁ

THERMO PRIME 75 RC2

ROZMIAR	ZAMEK GŁÓWNY	ZAMEK DODATKOWY	LICZBA KLUCZY	KLASA WKŁADKI	CENA
45/55	ZABIERAK	KLAMKA / KLAMKA DO WEWN.	5+MONTAŻOWE	5	135 ZŁ
30/55	ZABIERAK	KLAMKA / POCHWYT DO WEWN.	5+MONTAŻOWE	5	105 ZŁ
45/55	ZABIERAK	KLAMKA / KLAMKA NA ZEWN.	5+MONTAŻOWE	5	135 ZŁ
30/45	ZABIERAK	KLAMKA / POCHWYT NA ZEWN.	5+MONTAŻOWE	5	95 ZŁ
G55/45	ZABIERAK	KLAMKA / KLAMKA DO WEWN.	5+MONTAŻOWE	5	135 ZŁ
G55/35	ZABIERAK	KLAMKA / POCHWYT DO WEWN.	5+MONTAŻOWE	5	115 ZŁ
G50/50	ZABIERAK	KLAMKA / KLAMKA NA ZEWN.	5+MONTAŻOWE	5	135 ZŁ
G50/35	ZABIERAK	KLAMKA / POCHWYT NA ZEWN.	5+MONTAŻOWE	5	105 ZŁ
45/55	ZABIERAK	KLAMKA / KLAMKA DO WEWN.	5+MONTAŻOWE	6	225 ZŁ
30/55	ZABIERAK	KLAMKA / POCHWYT DO WEWN.	5+MONTAŻOWE	6	195 ZŁ
45/55	ZABIERAK	KLAMKA / KLAMKA NA ZEWN.	5+MONTAŻOWE	6	225 ZŁ
30/45	ZABIERAK	KLAMKA / POCHWYT NA ZEWN.	5+MONTAŻOWE	6	185 ZŁ
G55/45	ZABIERAK	KLAMKA / KLAMKA DO WEWN.	5+MONTAŻOWE	6	225 ZŁ
G55/35	ZABIERAK	KLAMKA / POCHWYT DO WEWN.	5+MONTAŻOWE	6	205 ZŁ
G50/50	ZABIERAK	KLAMKA / KLAMKA NA ZEWN.	5+MONTAŻOWE	6	225 ZŁ
G50/35	ZABIERAK	KLAMKA / POCHWYT NA ZEWN.	5+MONTAŻOWE	6	195 ZŁ

WYMIARY DRZWI I OŚCIEŻNIC

GERDA®

WYMIARY SKRZYDŁA DRZWI THERMO PRIME / THERMO PREMIUM [mm]

SZEROKOŚĆ

ROZMIAR	MODEL DRZWI	SZEROKOŚĆ SKRZYDŁA STRONA WĘŻSZA (Sp)	SZEROKOŚĆ SKRZYDŁA STRONA SZERSZA (Ss)
80	THERMO PRIME / THERMO PREMIUM	812	842
90N		882	912
90E		925	955
100E		1025	1055

WYSOKOŚĆ

MODEL DRZWI	WYSOKOŚĆ	WYSOKOŚĆ SKRZYDŁA STRONA WĘŻSZA (Hs)	WYSOKOŚĆ SKRZYDŁA STRONA SZERSZA (Hp)
T. PRIME / T.PREMIUM	2087	2009	2039
THERMO PRIME	2100	2022	2052
	2150	2072	2102
	2200	2122	2152
	2250	2172	2202
	2300	2222	2252
	2350	2272	2302
	2400	2322	2352

WYMIAR OŚCIEŻNIC ALUTHERM PRIME / ALUTHERM PREMIUM / DUOTHERM [mm]

ROZMIAR	MODEL OŚCIEŻNICY	CAŁKOWITA SZEROKOŚĆ OŚCIEŻNICY (Sc)	ZALECANA SZEROKOŚĆ OTWORU MONTAŻOWEGO (Sm)*	CAŁKOWITA WYSOKOŚĆ OŚCIEŻNICY(Hc)	ZALECANA WYSOKOŚĆ OTWORU MONTAŻOWEGO (Hm) OD POZIOMU "0"
80	DUOTHERM	896	916	2076	2086
90 N		966	986		
90 E		1009	1029		
100 E		1109	1129		
80	ALUTHERM	918	938	STANDARD 2087 NIESTANDARDOWE**	STANDARD 2097 NIESTANDARDOWE**
90 N		988	1008		
90 E		1031	1051		
100 E		1131	1151		

* ZAWIERA LUZ MONTAŻOWY 10 mm

** TYLKO THERMO PRIME

THERMO PRIME 75 / THERMO PREMIUM 75

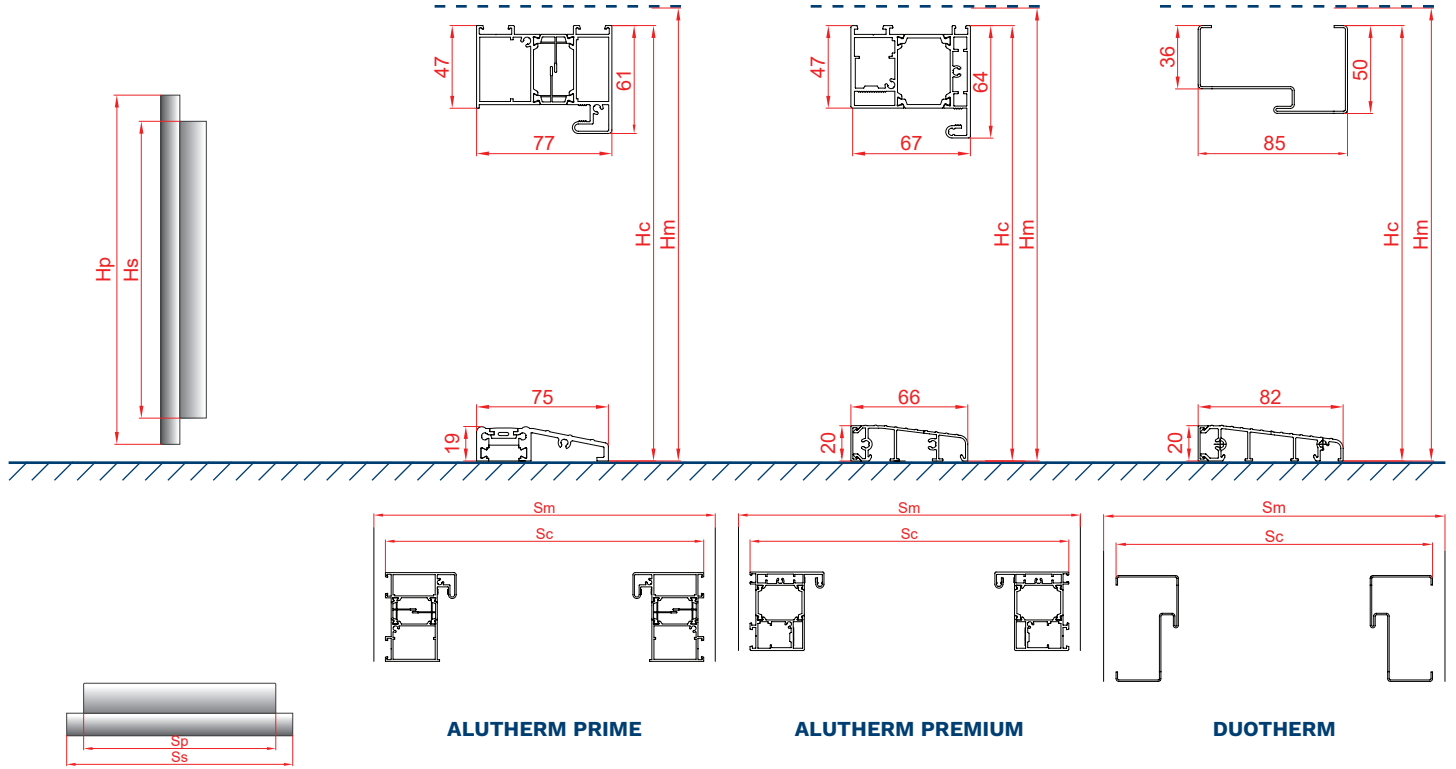

THERMO PREMIUM 60

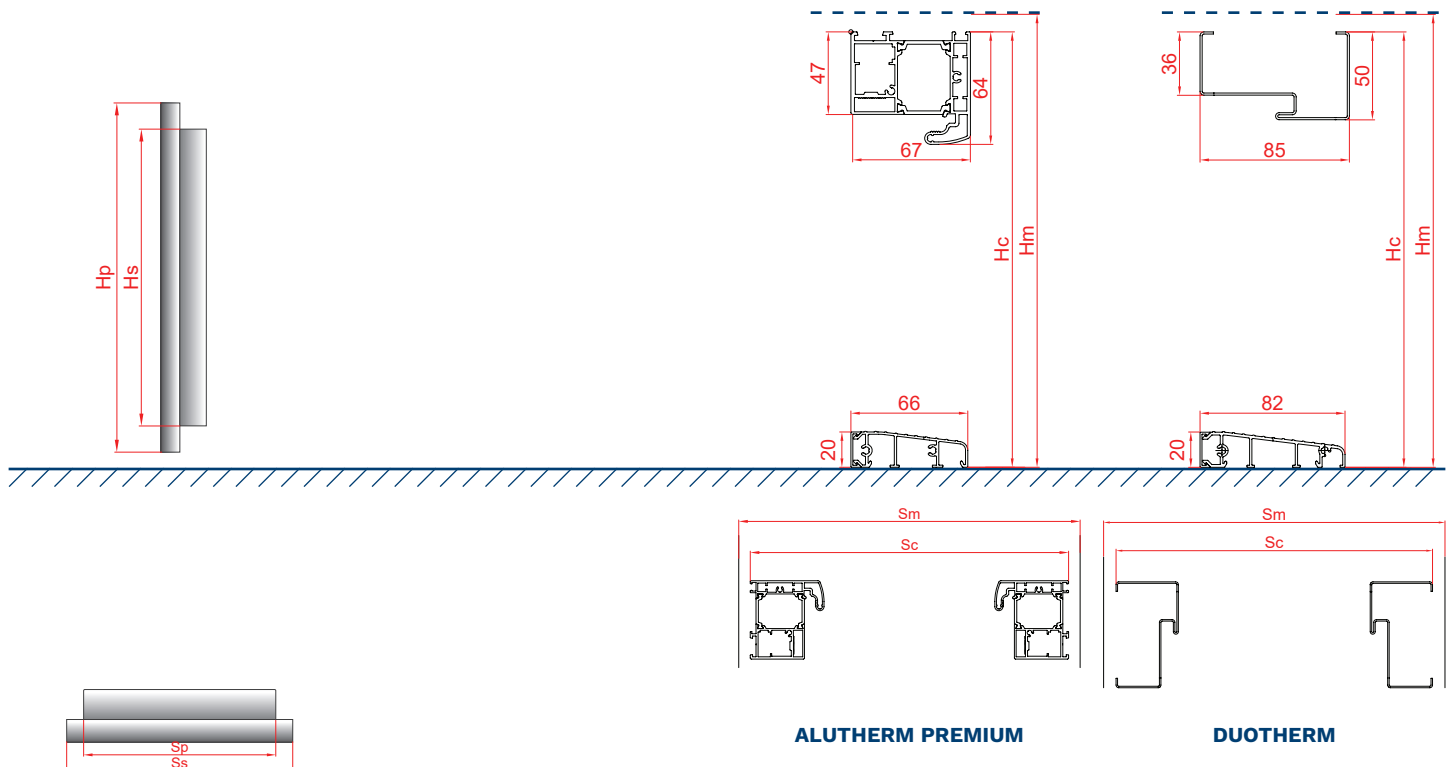

* DRZWI W KOLORACH CIEMNYCH NIE NALEŻY MONTOWAĆ W MIEJSCACH DŁUGOTRWAŁEGO I BEZPOŚREDNIEGO NASŁONECZNIENIA. DRZWI MONTOWANE JAKO WEJŚCIOWE ZEWNĘTRZNE W MIEJSCACH NARAŻONYCH NA BEZPOŚREDNIE DZIAŁANIE CZYNNIKÓW ATMOSFERYCZNYCH (DESZCZ, WIATR, ITP.) WINNY BYĆ DRZWIAMI OTWIERANYMI NA ZEWNĄTRZ. W PRZYPADKU DRZWI MONTOWANYCH JAKO DRZWI WEJŚCIOWE ZEWNĘTRZNE WYMAGANE JEST ZASTOSOWANIE ZADASZENIA.

WYMIARY DRZWI I OŚCIEŻNIC

WYMIARY SKRZYDŁA DRZWI OPTIMA [mm]

ROZMIAR	MODEL DRZWI	SZEROKOŚĆ SKRZYDŁA STRONA WĘŻSZA (Sp)	SZEROKOŚĆ SKRZYDŁA STRONA SZERSZA (Ss)	WYSOKOŚĆ SKRZYDŁA STRONA WĘŻSZA (Hs)	WYSOKOŚĆ SKRZYDŁA STRONA SZERSZA (Hp)
80N	OPTIMA	782	812	2023	2038,5
80		812	842		
90N		882	912		
90E		925	955		
100E		1025	1055		
30	OPTIMA DUO 60	257	287		
40		357	387		
50		457	487		

ROZMIAR OŚCIEŻNIC ALUTHERM OPTIMA, PERFOTHERM, FB [mm]

ROZMIAR	MODEL OŚCIEŻNICY	CAŁKOWITA SZEROKOŚĆ OŚCIEŻNICY (Sc)	ZALECANA SZEROKOŚĆ OTWORU MONTAŻOWEGO (Sm)*	CAŁKOWITA WYSOKOŚĆ OŚCIEŻNICY (Hc)	ZALECANA WYSOKOŚĆ OTWORU MONTAŻOWEGO (Hm) OD POZIOMU "0"
80N	PERFOTHERM, FB	866	886	2076	2086
80		896	916		
90 N		966	986		
90 E		1009	1029		
100 E		1109	1129		
80	ALUTHERM	918	938	2087	2097
90 N		988	1008		
90 E		1031	1051		
100 E		1131	1151		

* ZAWIERA LUZ MONTAŻOWY 10 mm

OPTIMA 60

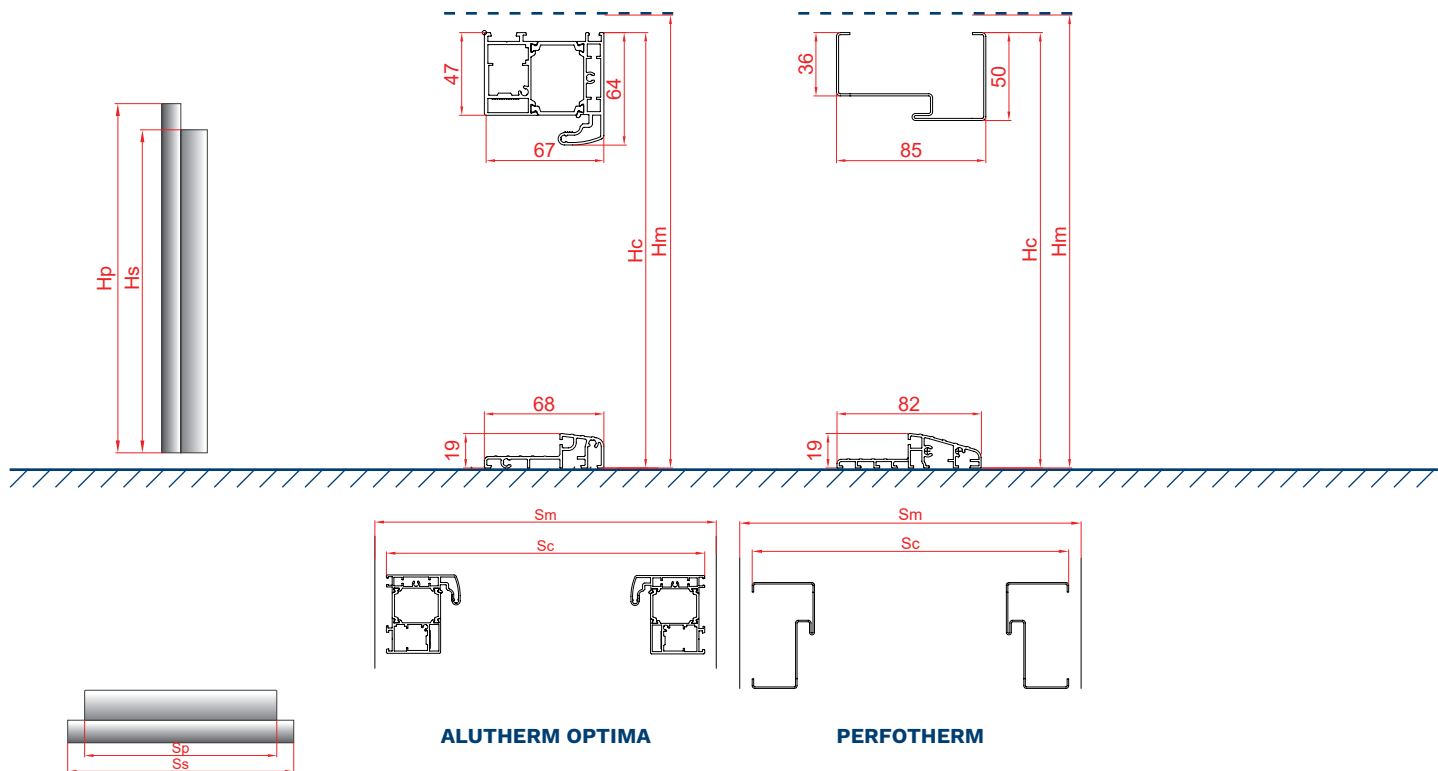

OPTIMA 50

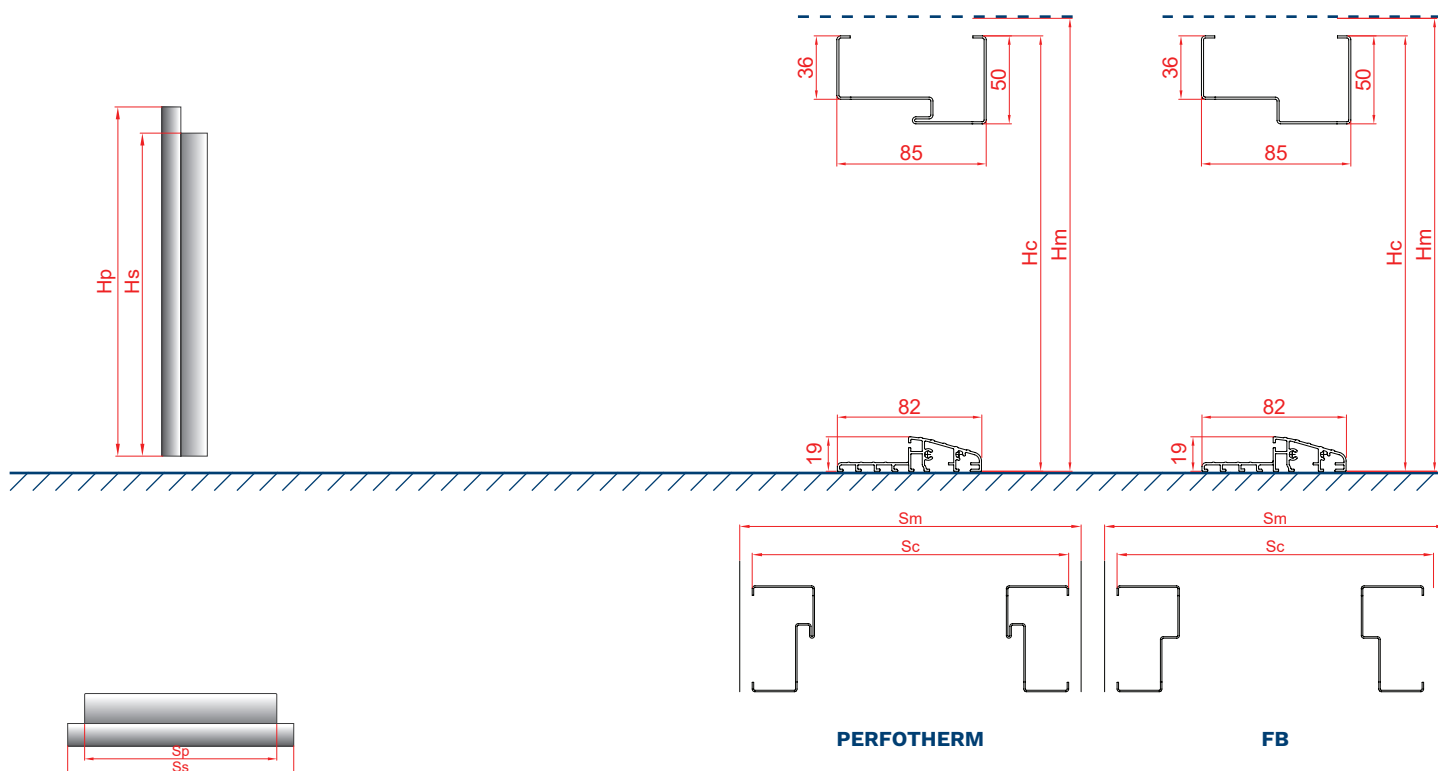

* DRZWI W KOLORACH CIEMNYCH NIE NALEŻY MONTOWAĆ W MIEJSCACH DŁUGOTRWAŁEGO I BEZPOŚREDNIEGO NASŁONECZNIENIA. DRZWI MONTOWANE JAKO WEJŚCIOWE ZEWNĘTRZNE W MIEJSCACH NARAŻONYCH NA BEZPOŚREDNIE DZIAŁANIE CZYNNIKÓW ATMOSFERYCZNYCH (DESZCZ, WIATR, ITP.) WINNY BYĆ DRZWIAMI OTWIERANYMI NA ZEWNĄTRZ. W PRZYPADKU DRZWI MONTOWANYCH JAKO DRZWI WEJŚCIOWE ZEWNĘTRZNE WYMAGANE JEST ZASTOSOWANIE ZADASZENIA.

WYMIARY DRZWI I OŚCIEŻNIC

ROZMIAR OŚCIEŻNIC FN DLA DRZWI OPTIMA [mm]

ROZMIAR	MODEL OŚCIEŻNICY	CAŁKOWITA SZEROKOŚĆ OŚCIEŻNICY (Sc1)	CAŁKOWITA SZEROKOŚĆ OŚCIEŻNICY (Sc2)	ZALECANA SZEROKOŚĆ OTWORU MONTAŻOWEGO (Sm)	CAŁKOWITA WYSOKOŚĆ OŚCIEŻNICY (Hc1)	CAŁKOWITA WYSOKOŚĆ OŚCIEŻNICY (Hc2)	ZALECANA WYSOKOŚĆ OTWORU MONTAŻOWEGO OD POZIOMU "0" (Hm)
80N	FN	862	797	817	2075	2041	2051
80		892	827	847			
90N		962	897	917			
90E		1005	940	960			
100E		1105	1040	1060			

ROZMIAR OŚCIEŻNIC ALUTHERM OPTIMA, PERFOTHERM DLA DRZWI OPTIMA DUO 60 [mm]

ROZMIAR	ALUTHERM		PERFOTHERM		ALUTHERM		PERFOTHERM	
	CAŁKOWITA SZEROKOŚĆ OŚCIEŻNICY (Sc)	"ZALECANA SZEROKOŚĆ OTWORU MONTAŻOWEGO (Sm)	CAŁKOWITA SZEROKOŚĆ OŚCIEŻNICY (Sc)	ZALECANA SZEROKOŚĆ OTWORU MONTAŻOWEGO (Sm)	CAŁKOWITA WYSOKOŚĆ OŚCIEŻNICY (Hc)	ZALECANA WYSOKOŚĆ OTWORU MONTAŻOWEGO OD POZIOMU "0" (Hm)	CAŁKOWITA WYSOKOŚĆ OŚCIEŻNICY (Hc)	ZALECANA WYSOKOŚĆ OTWORU MONTAŻOWEGO OD POZIOMU "0" (Hm)
80	918	938	896	916	2087	2097	2076	2086
80+30	1209	1229	1187	1207				
80+40	1309	1329	1287	1307				
80+50	1409	1429	1387	1407				
90 E	1031	1051	1009	1029				
90 E +30	1322	1342	1300	1320				
90 E +40	1422	1442	1400	1420				
90 E +50	1522	1542	1500	1520				
100 E	1131	1151	1109	1129				
100 E +30	1422	1442	1400	1420				
100 E +40	1522	1542	1500	1520				
100 E +50	1622	1642	1600	1620				

* ZAWIERA LUZ MONTAŻOWY 10 mm

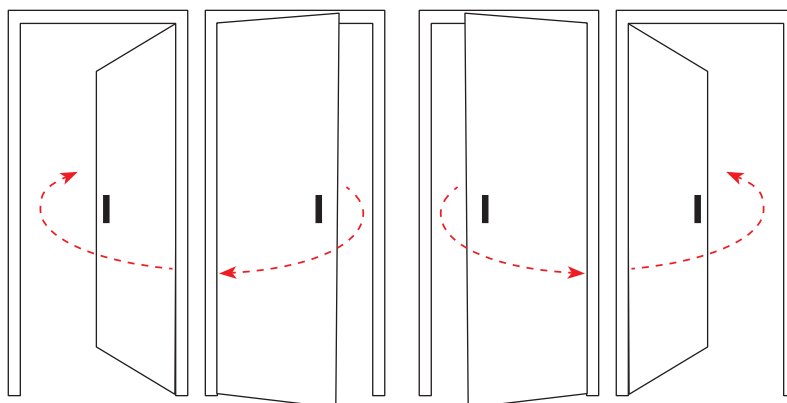

DRZWI LEWE

DRZWI PRAWY

OPTIMA 50

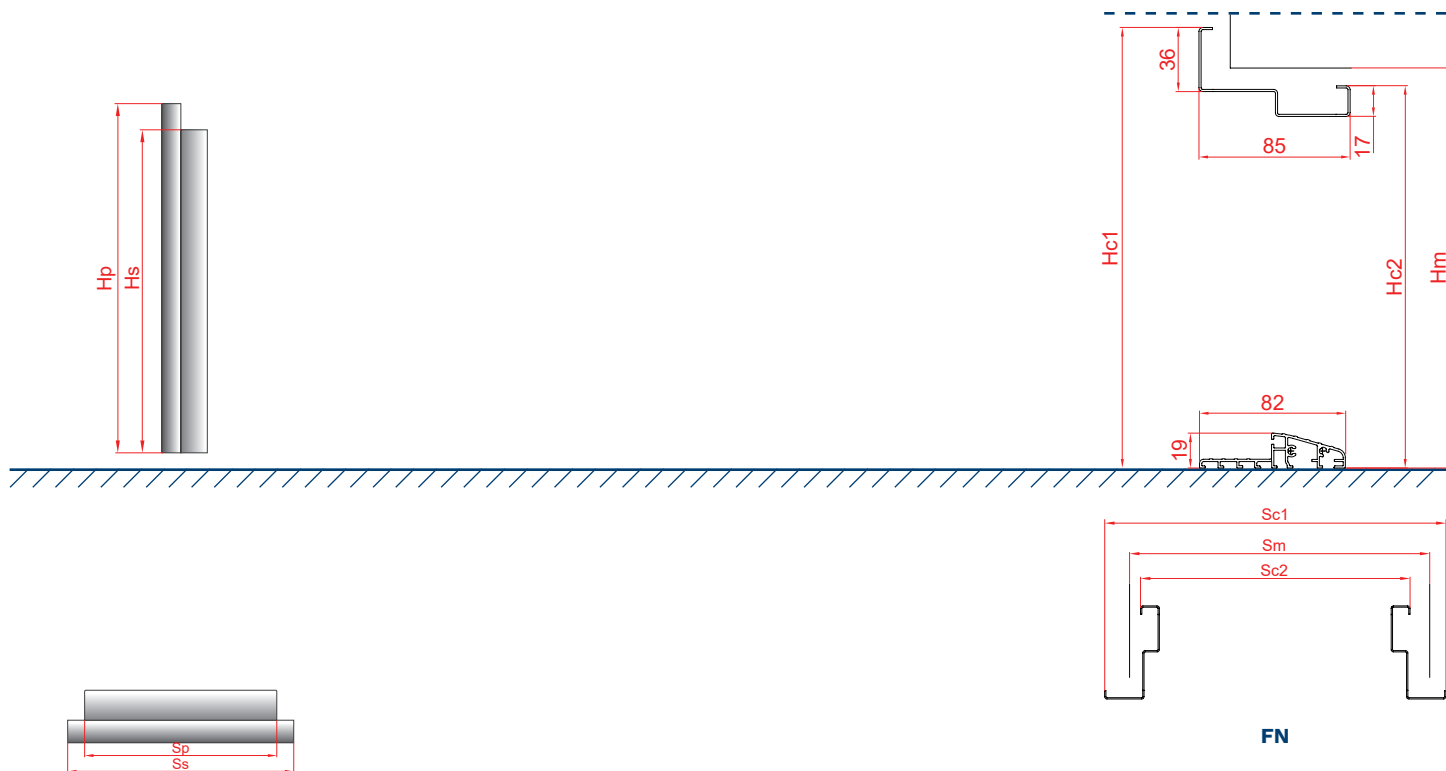

DUO

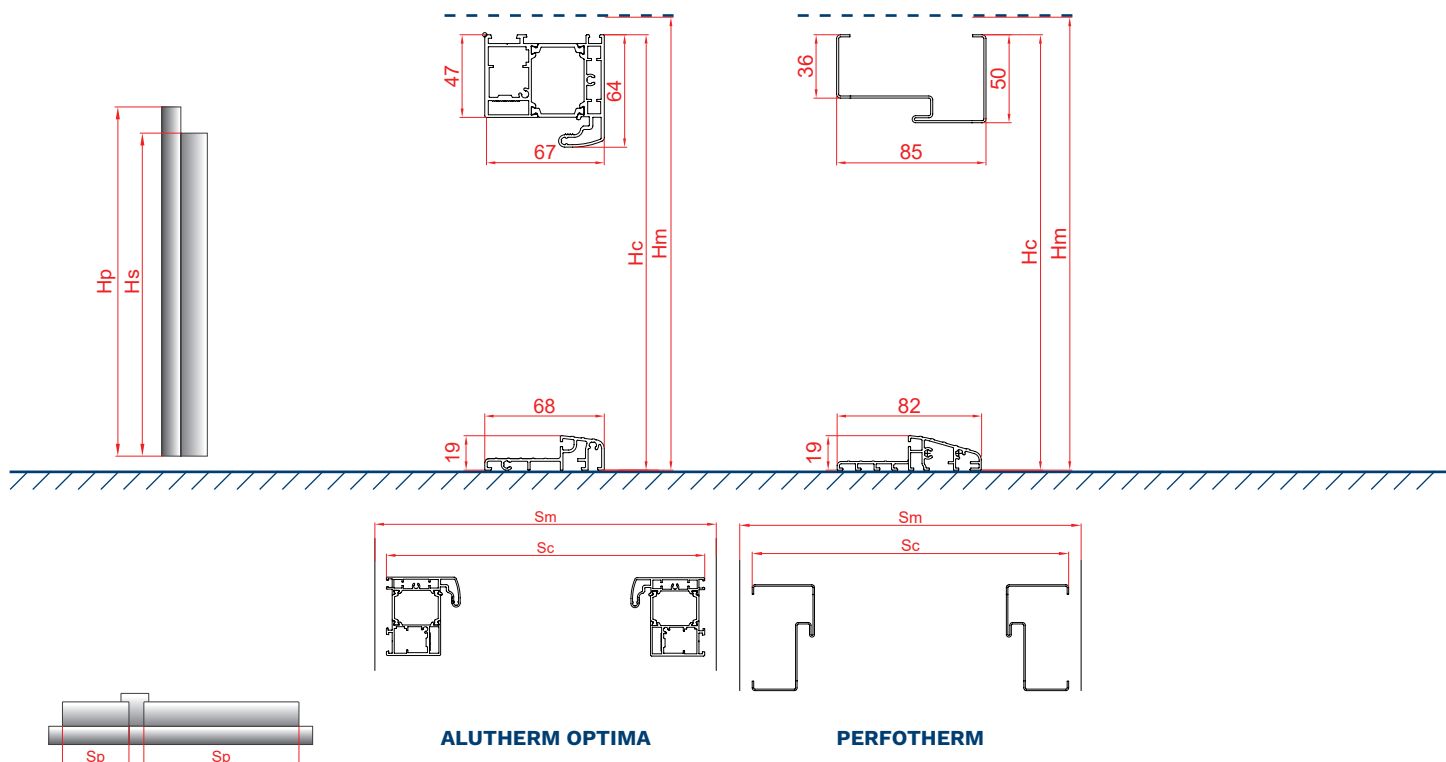

* DRZWI W KOLORACH CIEMNYCH NIE NALEŻY MONTOWAĆ W MIEJSCACH DŁUGOTRWAŁEGO I BEZPOŚREDNIEGO NASŁONECZNIENIA. DRZWI MONTOWANE JAKO WEJŚCIOWE ZEWNĘTRZNE W MIEJSCACH NARAŻONYCH NA BEZPOŚREDNIE DZIAŁANIE CZYNNIKÓW ATMOSFERYCZNYCH (DESZCZ, WIATR, ITP.) WINNY BYĆ DRZWIAMI OTWIERANYMI NA ZEWNĄTRZ. W PRZYPADKU DRZWI MONTOWANYCH JAKO DRZWI WEJŚCIOWE ZEWNĘTRZNE WYMAGANE JEST ZASTOSOWANIE ZADASZENIA.

INSPIRACJE
UKRYTE W REALIZACJACH



GERDA[®] INSPIRACJE UKRYTE W REALIZACJACH





Gerda Sp. z o.o.

Sokołów, ul. Sokołowska 49
05-806 Komorów
Tel.: (+48 22) 329 10 30

www.gerda.pl

Dystrybutor:

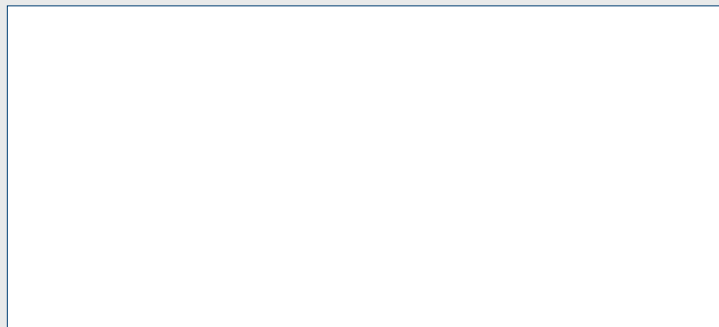

Niniejszy katalog produktów nie stanowi oferty w rozumieniu prawa i ma jedynie charakter informacyjny.

Podane ceny są orientacyjne i nie ustalają cen odsprzedaży dla podmiotów oferujących produkty Gerda Sp. z o.o.

Podane ceny nie zawierają podatku VAT.

Produkt objęty jest 3 letnią gwarancją, szczegóły na stronie www.gerda.pl/serwis/uslugi/przedluz-gwarancje/

Firma Gerda, dążąc do coraz lepszej jakości swoich wyrobów i usług zastrzega sobie (bez wcześniejszego powiadomienia) prawo do wprowadzania zmian w produktach, których z uwagi na proces przygotowywania materiałów drukowanych może nie zawierać niniejszy materiał.

Mimo starań w zakresie dokładnej kontroli prezentowanych informacji mogą zdarzyć się błędy merytoryczne lub drukarskie.

Kolory prezentowane w katalogu mogą różnić się od oryginału z uwagi na inną technikę odwzorowania koloru w procesie druku.

Właścicielem praw autorskich niniejszego katalogu i logotypów Gerda oraz elementów graficznych jest Gerda Sp. z o.o.

Zabronione jest kopiowanie i dystrybucja wszelkich treści i materiałów bez uprzedniej zgody Gerda Sp. z o.o.